

Demand Response with Variable-Capacity Light Commercial HVAC Systems

DR17.18



Prepared by:

Electric Power Research Institute (EPRI)

For:

Emerging Products & Technologies

Customer Service

Southern California Edison

September 2020

Acknowledgements

Southern California Edison's (SCE) Emerging Products and Technologies (EP&T) group is responsible for this project. It was developed as part of SCE's Emerging Markets and Technology (EM&T) Program under internal project number DR17.18. Rafik Sarhadian conducted this technology evaluation, with overall guidance and management from Jerine Ahmed and Sean Gouw. Contact Rafik.Sarhadian@sce.com for more information on this project.

Disclaimer

This report was funded by California utility customers under the auspices of the California Public Utilities Commission (CPUC). Reproduction or distribution of the whole or any part of the contents of this document without the express written permission of SCE is prohibited. This work was performed with reasonable care and in accordance with professional standards. However, neither SCE nor any entity performing the work pursuant to SCE's authority make any warranty or representation, expressed or implied, with regard to this report, the merchantability or fitness for a particular purpose of the results of the work, or any analyses or conclusions contained in this report. The results reflected in the work are generally representative of operating conditions; however, the results in any other situation may vary depending upon particular operating conditions.

EXECUTIVE SUMMARY

Demand Response (DR) programs play an important role in allowing SCE to provide reliable, affordable, and environmentally-responsible electricity to its customers. As California transitions to renewable energy sources as part of statewide goals to reduce Greenhouse Gas (GHG) emissions (as described in SCE's [Pathway 2045](#)), the flexibility and resilience of customer resources will be increasingly valuable for managing the inherent variability of these non-dispatchable resources. Due to its contribution to system peak, Heating, Ventilation, and Air-Conditioning (HVAC) equipment is key in helping utility programs manage electricity demand.

Variable-Capacity (VC) HVAC equipment provides enhanced Energy Efficiency (EE) and customer comfort benefits over conventional fixed-speed equipment. For light commercial applications, Variable Refrigerant Flow (VRF) systems and packaged Rooftop Units (RTUs) leverage variable-speed components and complex controls to achieve superior part-load efficiency over conventional equipment. Numerous studies have been completed in recent years to assess the benefits of variable HVAC systems, which have become a valuable resource in utility EE programs.

Yet the variable-speed capabilities of these systems have not been fully leveraged for DR. With their on-board instrumentation and communications capabilities, VC systems are prime candidates for implementing both EE and DR functionality, potentially offering dual program participation. The implementation of DR control strategies that leverage the superior part-load efficiency of these systems could enable greater demand reduction or reduced impact on occupant comfort over DR with conventional fixed-speed HVAC systems.

This project sought to address this market gap by demonstrating advanced DR control strategies for VC air-to-air HVAC systems in light commercial buildings in SCE territory. After outreach to several companies to partner in this project, a producer of variable-speed RTUs (Manufacturer A) and a major manufacturer of VRF systems (Manufacturer B) agreed to participate. Manufacturer B, the VRF system manufacturer, implemented a conventional DR strategy and supported OpenADR 2.0b, as well as three advanced DR strategies:

- Change in thermostat setpoint temperature (conventional strategy).
- Limit equipment thermal capacity (and therefore electric power) subject to a maximum allowable deviation in indoor temperature.
- Change in temperature setpoint to increase capacity delivery ("load up" to enable pre-cooling).
- Targeted capacity reduction, where cooling or heating is turned off for specific zones to meet the target reduction based on zone priority.

SCE helped identify field sites for each technology in light commercial buildings that represent typical applications in their service territory, and one was selected for each technology (two total). Each site was instrumented with power monitoring and temperature sensors so HVAC system response and the impact on indoor temperatures could be analyzed in detail.

For the VRF system, the findings of this study indicate that Capacity Limit control can reduce electrical demand with minimal impact on indoor temperatures. During tests with outdoor temperatures around 95°F, Capacity Limit control consistently provided 15-25% reduction in average power during 1- or 2-hour DR events compared to baseline. The strategy of Pre-cooling followed by Capacity Limit control also provided a 15% reduction. However, the other two major control strategies testing—Setpoint Offset and Targeted Capacity Reduction, where VRF indoor conditioned zones were disabled in a specific order—did not consistently reduce demand on peak days. Test results indicated that Setpoint Offset—the strategy most similar to conventional HVAC DR control using thermostats—could also significantly reduce VRF demand at mild outdoor temperatures.

The VRF system was found to respond as expected to commands sent via OpenADR 2.0b, and an OpenADR Virtual Top Node (VTN) was used to schedule and initiate test events. As a result of participation in this study, Manufacturer B has integrated this advanced DR control strategy into a controller designed for commercial buildings.

For the variable-speed packaged RTU, Manufacturer A, while understanding the benefits of DR, was unable to implement advanced DR controls or OpenADR support during this project. For this RTU, remote control of conventional setpoint offset events could only be initiated manually via a web portal. Several tests were completed using the web portal method, with mixed results. A significant time delay (15 to 60 minutes) was experienced between when the DR signal was sent, when the unit reacted, and when acknowledgement was received. On-site power and temperature measurements indicated the RTU did not take full advantage of its variable-speed capabilities for DR and instead shut off in response to setpoint offset commands in several test events, much like a conventional single-speed system.

Project findings suggest several follow-on activities of interest. An industry standard should be developed to harmonize DR responses from variable-speed HVAC systems in this class. Unless a standard is available, manufacturers will continue to ask for a unified list of specific responses they can implement without creating custom solutions for each program. Recently, Air-Conditioning, Heating, and Refrigeration Institute (AHRI) Standard 1380 was published for VC HVAC equipment of less than 65,000 Btu/h (5.4 tons), which could be used as a starting point to define similar or enhanced DR responses for larger equipment (for example, 5.4 – 60 tons).

Additional field testing of larger Manufacturer B VRF systems would be beneficial for several reasons. First, Manufacturer B recently integrated the DR controls tested in this study into a lower-cost controller, which has not been independently verified. Second, testing with a VRF system larger than approximately 14 tons would allow a greater level of demand reduction control, due to the additional capacity stages available. Furthermore, this project tested the equipment serving zones that had very low occupancy. Additional larger-scale field testing will provide a better understanding of how these controls perform under various loading conditions and building types, allowing a more detailed evaluation of the DR potential and possible impact on occupant comfort at scale, before full program rollout.

Lastly, it would be advantageous to work with additional equipment manufacturers to expand the EE DR opportunity for this class of equipment. Several manufacturers have told EPRI they are beginning to assess and implement these types of controls in their light commercial variable-speed products. These manufacturers are eager to provide value to electric utilities with enhanced DR capabilities, but need assistance in implementing and testing the new controls.

ABBREVIATIONS AND ACRONYMS

A	Amperage
AHRI	Air-Conditioning, Heating, and Refrigeration Institute
ANSI	American National Standards Institute
ASHRAE	American Society of Heating, Refrigerating and Air-Conditioning Engineers
BAS	Building Automation System
BMS	Building Management System
Btu/h	British Thermal Unit per Hour
CT	Current Transformer
CTA-2045	Consumer Technology Association
DDC	Direct Digital Control
DER	Distributed Energy Resource
DR	Demand Response
EER	Energy Efficiency Ratio
EMS	Energy Management System
EPRI	Electric Power Research Institute
GUI	Graphical User Interface
HVAC	Heating, Ventilation, and Air-Conditioning
IDU	Indoor Unit

IEER	Integrated Energy Efficiency Ratio
kW	Kilowatt
kWh	Kilowatt Hour
ODU	Outdoor Unit
OpenADR	Open Automated Demand Response
PII	Personally-Identifiable Information
RH	Relative Humidity
RTU	Rooftop Unit
SEER	Seasonal Energy Efficiency Ratio
V	Voltage
VC	Variable-Capacity
VEN	Virtual End Node
VPN	Virtual Private Network
VRF	Variable Refrigerant Flow
VTN	Virtual Top Node
°C	Degrees Celsius
°F	Degrees Fahrenheit
°F/h	Degrees Fahrenheit per Hour

CONTENTS

INTRODUCTION	1
REVIEW OF AVAILABLE TECHNOLOGIES	2
Background	2
Rooftop Unit Market	3
Variable Refrigerant Flow Market	4
Communications and Controls Approaches	5
Communications Barriers and Solutions	6
DR Capabilities of Variable-Capacity Rooftop Packaged Units	7
Market Study of Auto-DR Capabilities of VRF Technology	7
Development of Advanced DR Capabilities	9
VRF Equipment Controls	10
RTU Controls	13
TECHNICAL APPROACH	16
Assessment Objectives	16
Instrumentation Plan	16
Electrical Parameters	16
Thermal Parameters	16
Instrumentation	16
Sensor and Power Meter Accuracy	17
Field Site Characteristics	17
Site 1 Characteristics	17
Site 2 Characteristics	20
Test Matrix	21
RESULTS	24
Methodology for DR Functionality Analysis	24
SUMMARY OF TEST RESULTS	25
Data Analysis – Site 1	27
Data Analysis – Site 2	31
CONCLUSION AND RECOMMENDATIONS	34
APPENDIX A: SITE 1 TEST DATA	35
APPENDIX B: SITE 2 TEST DATA	43
REFERENCES	46

FIGURES

FIGURE 1: COMPARISON OF DUTY CYCLE AND VARIABLE CONTROL FOR 50% AVERAGE POWER	2
FIGURE 2: COMPARISON OF DR EVENT WITH THERMOSTAT PRECOOLING AND LOAD SHED VERSUS BASELINE WITHOUT DR [5]	3
FIGURE 3: MFG. B VRF EQUIPMENT CONTROL GUI	11
FIGURE 4: MFG. A RTU CONTROL GUI	14
FIGURE 5: MFG. A RTU DEMAND SHED CONTROLS	14
FIGURE 6: SITE 1 DIAGRAM SHOWING VRF SYSTEM AND MONITORING EQUIPMENT	18
FIGURE 7: TEST 1 AT SITE 1	19
FIGURE 8: SITE 2 RTU	20
FIGURE 9: SITE 2 INSTRUMENTATION LAYOUT	20
FIGURE 10: SITE 1 TYPICAL OPERATING PROFILE (BASELINE SUMMER DAY)	21
FIGURE 11: SITE 2 TYPICAL OPERATING PROFILE (BASELINE SUMMER DAY)	21
FIGURE 12: SITE 1 TEST EVENT DETAILS AND BASELINE COMPARISON – TEST 8 (CAPACITY LIMIT)	27
FIGURE 13: SITE 1 TEST EVENT DETAILS AND BASELINE COMPARISON – TEST 7 (SETPOINT OFFSET)	28
FIGURE 14: SITE 1 TEST EVENT DETAILS AND BASELINE COMPARISON – TEST 12 (PRE-COOLING)	28
FIGURE 15: MIS-OPERATION OF RAMPED RECOVERY FOR TEMPERATURE SETBACK EVENTS AT SITE 1	29
FIGURE 16: PLOT OF DEMAND REDUCTION FROM ALL TEST EVENTS AT SITE 1	30
FIGURE 17: COMPARISON OF CAPACITY LIMIT AND SETPOINT OFFSET CONTROL AT SITE 1	31
FIGURE 18: COMMUNICATIONS ERROR WITH CLOUD DASHBOARD FOR RTU CONTROLS	32
FIGURE 19: TEMPERATURE SETPOINT OFFSET AT SITE 2	33
FIGURE 20: TEMPERATURE SETPOINT OFFSET WITH RAMPED RECOVERY AT SITE 2	33
FIGURE 21: SITE 1 TEST EVENT DETAILS AND BASELINE COMPARISON – TEST 1	35
FIGURE 22: SITE 1 TEST EVENT DETAILS AND BASELINE COMPARISON – TEST 2	36
FIGURE 23: SITE 1 TEST EVENT DETAILS AND BASELINE COMPARISON – TEST 3	36
FIGURE 24: SITE 1 TEST EVENT DETAILS AND BASELINE COMPARISON – TEST 4	37
FIGURE 25: SITE 1 TEST EVENT DETAILS AND BASELINE COMPARISON – TEST 5	37
FIGURE 26: SITE 1 TEST EVENT DETAILS AND BASELINE COMPARISON – TEST 6	38
FIGURE 27: SITE 1 TEST EVENT DETAILS AND BASELINE COMPARISON – TEST 7	38
FIGURE 28: SITE 1 TEST EVENT DETAILS AND BASELINE COMPARISON – TEST 8	39
FIGURE 29: SITE 1 TEST EVENT DETAILS AND BASELINE COMPARISON – TEST 9	39
FIGURE 30: SITE 1 TEST EVENT DETAILS AND BASELINE COMPARISON – TEST 10	40
FIGURE 31: SITE 1 TEST EVENT DETAILS AND BASELINE COMPARISON – TEST 11	40
FIGURE 32: SITE 1 TEST EVENT DETAILS AND BASELINE COMPARISON – TEST 12	41
FIGURE 33: SITE 1 TEST EVENT DETAILS AND BASELINE COMPARISON – TEST 13	41
FIGURE 34: SITE 1 TEST EVENT DETAILS AND BASELINE COMPARISON – TEST 14	42

FIGURE 35: SITE 1 TEST EVENT DETAILS AND BASELINE COMPARISON – TEST 15	42
FIGURE 36: SITE 2 TEST EVENT DETAILS AND BASELINE COMPARISON – TEST 1.....	43
FIGURE 37: SITE 2 TEST EVENT DETAILS AND BASELINE COMPARISON – TEST 2.....	43
FIGURE 38: SITE 2 TEST EVENT DETAILS AND BASELINE COMPARISON – TEST 3.....	44
FIGURE 39: SITE 2 TEST EVENT DETAILS AND BASELINE COMPARISON – TEST 4.....	44
FIGURE 40: SITE 2 TEST EVENT DETAILS AND BASELINE COMPARISON – TEST 5.....	45
FIGURE 41: SITE 2 TEST EVENT DETAILS AND BASELINE COMPARISON – TEST 6.....	45

TABLES

TABLE 1:	VARIABLE-CAPACITY RTUS AVAILABLE ON THE MARKET	4
TABLE 2:	SUMMARY OF ADR-READINESS BY MANUFACTURER IN 2016	9
TABLE 3:	AVAILABLE CAPACITY LEVELS	12
TABLE 4:	OPENADR 2.0 VRF EQUIPMENT ADVANCED DR CONTROLS MAPPING	13
TABLE 5:	MONITORING EQUIPMENT ACCURACY	17
TABLE 6:	SITE 1 (IRWINDALE) CHARACTERISTICS	19
TABLE 7:	SITE 1 (IRWINDALE) TEST MATRIX	22
TABLE 8:	SITE 2 (SIMI VALLEY) TEST MATRIX	23
TABLE 9:	SITE 1 (IRWINDALE) TEST RESULTS.....	25
TABLE 10:	SITE 2 (SIMI VALLEY) TEST RESULTS	26

INTRODUCTION

Variable-capacity (VC) heating, ventilation, and air-conditioning (HVAC) equipment provides enhanced EE and customer comfort benefits over conventional, single-speed or two-speed equipment. For commercial applications, VRF systems as well as RTUs (from manufacturers A, F, and G) all leverage variable-speed compressors, electronic expansion valves, and a variety of refrigerant management controls to match HVAC system output to the building's cooling and heating requirements. These systems have extensive on-board instrumentation and processing power, which optimizes system operation and enables the comfort and efficiency advantages for which this equipment is known. In recent years, EPRI has gained a thorough understanding and insight to these systems through laboratory and field evaluations, including field testing in Southern California. Results from these studies found efficiency gains of between 20% and 40% from using VRF systems over baseline equipment [1] [2].

While the efficiency and comfort benefits of VC HVAC have been well documented, their DR capabilities have not been fully demonstrated. With their on-board instrumentation and communications capabilities, VC systems are prime candidates for implementing both EE and DR functionality, potentially offering dual program participation. Moreover, with their superior efficiency at part-load operation, VC equipment has the potential to provide improved DR over baseline equipment, in terms of response time, occupant comfort, and operating efficiency.

The main objective of this study was to evaluate the DR potential of VC HVAC equipment in light commercial building applications through demonstrations at two field sites in Southern California. This report provides the following information summarizing project activities: background on VC HVAC for commercial applications, including VRF and RTU equipment, their DR capabilities, and communications approaches; the testing approach and instrumentation plan followed in this project; results from field testing VRF and RTU equipment at two sites in Southern California; and detailed test data (in the Appendices).

REVIEW OF AVAILABLE TECHNOLOGIES

BACKGROUND

This report focuses on VC light commercial HVAC equipment. The systems considered for this report came from product lines that ranged from five to 30 tons of cooling (17.6 to 105.5 kW thermal) intended to condition small-to-medium-sized commercial buildings. In general, commercial building HVAC is dominated by packaged (unitary) RTUs, which are estimated to represent over 50% of commercial floorspace in the U.S. Named for their typical installation location, RTUs can be installed on the roof or at ground level. These systems are typically air-conditioning units with gas, propane, or electric resistance heating, although heat pumps are common in some climates (previous studies provide additional information on commercial rooftop HVAC systems, [3] and [4]).

In addition to RTUs, this project considers VRF systems for commercial buildings. These systems include a VC Outdoor Unit (ODU) connected to multiple Indoor Units (IDUs). The IDUs may have air distribution ductwork (known as ducted units), or ductless units located directly in the conditioned space, or a combination of the two.

In contrast, large buildings with cooling loads of above 100 tons or 350 kW (i.e., 1 ton of refrigeration is about 3.5 kW) often have hydronic heating and cooling systems, typically using pure water (or sometimes a water-glycol mixture) with chiller and boiler equipment. Such buildings often have dedicated facilities staff, and may use a central controller, such as a Building Automation System (BAS) or Energy Management System (EMS).

Conventional unitary HVAC systems typically use a single-speed compressor to provide cooling (and heating, for heat pumps). To satisfy part-load conditions, these systems must cycle on and off in duty cycle control to maintain the desired indoor temperature (Figure 1 shows an example of the difference between duty cycle and variable control). Yet this cycling behavior, which is fundamental to conventional, single-speed systems, is inherently inefficient. During each startup, the system is in its least-efficient state, because its mechanical components have not reached operating temperature and pressure. In recent years, advanced systems with VC components have become available in the marketplace for both commercial and residential HVAC systems. This feature allows the systems to operate more efficiently at part-load conditions.

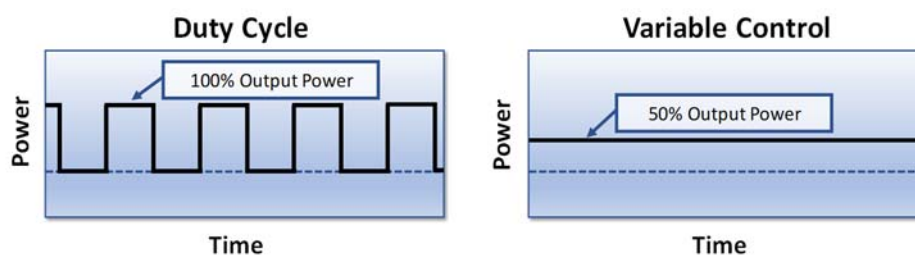

FIGURE 1: COMPARISON OF DUTY CYCLE AND VARIABLE CONTROL FOR 50% AVERAGE POWER

While offering significant advances in system efficiency, little has been done to develop the capability of VC systems to provide DR to the electric power system. With conventional HVAC systems, DR has typically been accomplished by altering the temperature setpoint of the conditioned space, causing the HVAC system to operate less frequently. This approach has two basic flaws. First, the sharp transition from normal operation to DR-enabled, and vice versa, creates an exaggerated dip in demand at the beginning of the DR period and a substantial rebound (“snapback”) at the end of the event (Figure 2). In some cases, this rebound has been found to cause even greater peak demand than if the DR event had not been initiated. The second problem with this approach is that it requires the conditioned space to deviate from comfortable conditions (assuming the original setpoint was chosen for comfort).

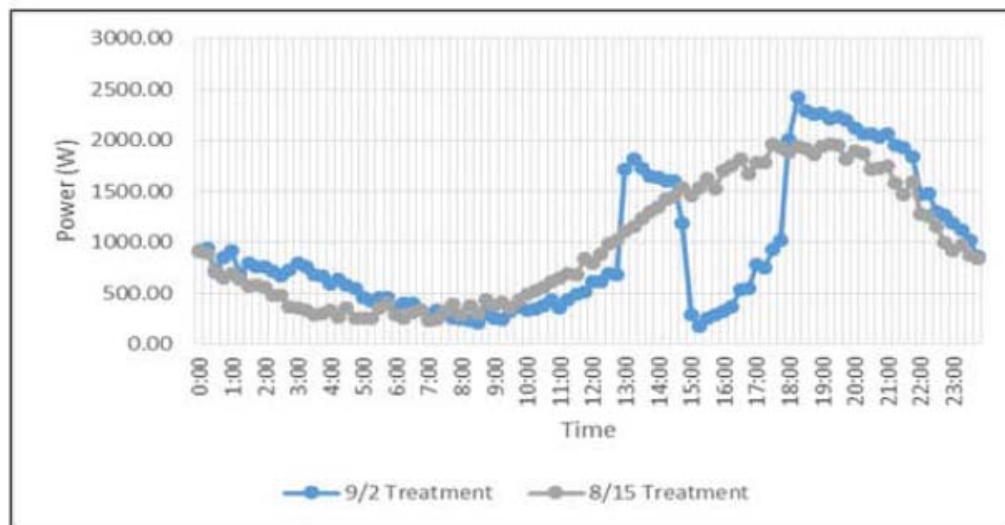

FIGURE 2: COMPARISON OF DR EVENT WITH THERMOSTAT PRECOOLING AND LOAD SHED VERSUS BASELINE WITHOUT DR [5]

In adjusting the temperature setpoint from the occupant-specified value, the overall load on the HVAC system is reduced during a DR event. Since VC systems are known to offer superior part-load efficiency over conventional HVAC, it is expected that they will offer improved DR performance as well. In other words, VC systems offer greater reduction in electrical power and/or reduced impact on occupant comfort, because they operate at higher part-load efficiency than conventional systems.

ROOFTOP UNIT MARKET

Table 1 lists some of the VC RTUs currently on the market, and indicates whether the model is a heat pump or air-conditioner only, as well as its size and efficiency (this list is not exhaustive). In addition to Energy Efficiency Ratio (EER), the part-load rating (either Seasonal EER [SEER] or Integrated EER [IEER], depending on unit size) is shown. ANSI/AHRI Standard 210/240 [6] defines SEER for systems below 65,000 Btu/h (5.4 tons or 18.5 kW). For systems above this size, AHRI Standard 340/360 [7] defines IEER. Both part-load efficiency ratings represent the weighted efficiency of the unit at different operating conditions, considering both part-load and full-load efficiency. As a point of reference, the minimum efficiency required by

ASHRAE Standard 90.1-2016 for air-cooled air conditioners between 5.4 and 11.3 tons of cooling (with electric heat) are 11.2 EER and 12.9 IEER, respectively [8].

TABLE 1: VARIABLE-CAPACITY RTUs AVAILABLE ON THE MARKET

Manufacturer	Mode	EER	IEER (SEER)	Size (tons)
H	AC or HP	up to 14.8	<19.2	3 - 6
H	AC or HP	up to 14.0		6 – 15
G	HP	13.0-13.7	17.9 – 21.9	3 – 23
A	HP	10.1-13.5	16.9 – 20.6	3 – 28
I	HP	12 – 15	20 – 23.5	3 – 20
F	AC	12.9-13.6	(19.4 – 20.1)	3 – 5
F	AC	12.3-12.7	19.3 – 20.1	12.5 – 17.5

VARIABLE REFRIGERANT FLOW MARKET

While VC technology has been a somewhat recent innovation in U.S. unitary HVAC, variable products have been available in Asian markets for some time. As noted, RTUs are the predominant HVAC technology in U.S. light commercial buildings, either in heat pump or air-conditioner form, which is a packaged (unitary) system using ductwork to distribute conditioned air to indoor zones. Yet the use of packaged HVAC, with its reliance on central ductwork, is much less common outside the U.S. In particular, Asian markets favor ductless (typically VC) split systems.

For the residential market, VRF systems can be single-zone split systems (an IDU combined with an ODU) or multi-zone (multiple IDUs to one ODU) and can be heat pump or cooling-only models. Multi-zone VRF systems are normally used in commercial applications (above approximately five tons [60,000 Btu/h or 17 kW] of cooling). Like residential multi-zone units, commercial VRF systems are often ductless and split (indoor coil and outdoor heat exchanger in separate chassis) and are offered as heat pump or heat recovery models. The primary difference is that heat recovery systems allow indoor zones to simultaneously operate in different modes (heating or cooling) while heat pumps require all zones to operate in the same mode.

VRF systems typically use direct control of each conditioned zone through a separate zone controller, which communicates over a proprietary local network with the other system components – typically IDUs, ODUs, and refrigerant branch controllers connected to the refrigerant circuit. Control setpoints may be programmed into each zone controller or may be configured at a central controller that coordinates system component operation. More complex VRF installations may also communicate with a building EMS, and are detailed later in this report (previous studies provide additional information on VRF technologies, [2], [9] and [10]).

Many companies offer VRF products in the U.S. due to the prevalence of this technology in Asia and to offer these efficient products to their U.S. customers.

U.S. manufacturers increasingly offer VRF products, whether sourced from another supplier and rebranded or produced under a joint venture with experienced VRF manufacturers.

Manufacturers A and B, in particular, have led research and development efforts in DR. Both offer residential ductless mini-split products, as well commercial VRF. Manufacturer A offers a number of ductless split systems; multi-splits systems are available in 2, 3, 4, and 8-zone models from 1.5 to four tons. Manufacturer A refers to its commercial line as *Variable Refrigerant Volume* (VRV), which is available in heat pump and heat recovery models from six to 38 tons. Manufacturer B's VRF product is available in heat pump (Y-series, six to 30 tons) and heat recovery (R2-series, six to 28 tons). Its multi-split series is the S-series, which ranges from three to five tons.

COMMUNICATIONS AND CONTROLS APPROACHES

As discussed in EPRI report [3002011045](#) [11], there are several different methods for communicating DR signals to end-use devices (thermostats, HVAC systems, lighting, etc.). These communication pathways can originate from a utility (assumed to be distribution or regional system operator), third-party aggregator or Distributed Energy Resource (DER) provider, or facility-level management system. Many utilities and system operators have begun to adopt open communication standards, including OpenADR and CTA-2045 (formerly CEA-2045). The primary difference between these two standards is that CTA-2045 includes a hardware specification, defining a physical port and the electrical signals transmitted through the interface. OpenADR defines more general communications about the event between a DR program administrator and end-use load without specifying hardware requirements. They are not mutually exclusive, and can be used together (a CTA-2045 hardware module that interprets OpenADR signals). To receive OpenADR commands, a device may be embedded with an OpenADR Virtual End Node (VEN), a program that receives and interprets the DR signals and may communicate a responding action to the device. In multiple instances, manufacturers are embedding VENs into their cloud interfaces to remotely communicate with local devices.

As noted earlier, larger buildings often make use of centralized building controllers to manage mechanical systems, lighting, security, etc. One approach is to use a BAS to centralize and automate commands to the various systems (to set back temperature setpoints, reduce lighting, and/or enable security systems when unoccupied). In contrast, an EMS monitors building system operations and provides the building manager with more insight into energy use. In addition, an EMS may provide tools to help manage energy use. These systems communicate with a data communications protocol such as BACnet® (a building automation and control network developed by ASHRAE), LonWorks™, Modbus, etc.

One of the most popular software platforms used to integrate building communications and controls is the Niagara Framework. This software enables developing applications for managing building systems and allows for internet communication. To connect to the various building communications systems and to provide centralized system management, a Java Application Control Engine (JACE) module is often used.

OpenADR event signals are received by a VEN, which directs an end-use device to alter its behavior. A VEN could be embedded into the BAS/EMS, a third-party

controller that communicates with HVAC controls, the HVAC controller itself, or a web-based VEN. Moreover, additional control logic is required to direct the system to respond to an OpenADR signal. Historically, HVAC equipment has been commanded to respond to DR signals by adjusting temperature setpoints closer to outdoor conditions (warmer during summer months, and cooler in winter months).

COMMUNICATIONS BARRIERS AND SOLUTIONS

Communications can be a major challenge for any grid-interactive functionality, particularly those that are not fully mature. It is important for any communication barriers to be identified early in the evaluation process, so suitable solutions can be developed. DR with VC HVAC is no exception and presents several potential communication barriers.

- Incompatibility of proprietary controls – the use of proprietary controls in any emerging DR functionality can present a significant barrier to adoption. The primary issue with proprietary controls is the restrictions that may be placed on their use, whether in terms of cost (for example, licensing fees) or terms and conditions of use imposed by the manufacturer. Such conditions may restrict the ability to use proprietary controls in a certain way (for example, they may prevent a DR program administrator from reading the current power level of a device) and require legal review for utility to acceptance.
 - Solution: compatibility with open communications standards (e.g. OpenADR or CTA-2045)
- Availability of internet communications access – for any grid-interactive control to be useful, it must communicate with a central manager, whether a DR management system or other controller that dispatches end-use devices for useful grid functions. Increasingly, these controls rely on the availability of internet access for communication, whether wired, wireless, or mobile, and each presents its own challenges. Although high-speed networking has become commonplace in commercial buildings, there are many situations in which internet access is not available at the space conditioning equipment location, particularly in retrofit applications. Moreover, external communications often require network administration to grant specific permissions allowing communications to the HVAC controls via the local firewall, which is typically more stringent in commercial buildings than residential. Cellular communications can provide a simple approach for deploying internet access in many locations, but the cost of high-speed connections can be prohibitive.
 - Potential solutions: manufacturers support flexible internet access options with simple installation and configuration, and built-in diagnostics tools, enabling integration with the local network available at each site.
- DR functions embedded in cloud controls – a growing number of HVAC manufacturers are offered cloud-based interfaces to manage, monitor, and control their equipment remotely. Some are beginning to embed the OpenADR VEN into their cloud to be communicated to the end-use devices, rather than directly into the devices. This can present several unique challenges to communicating DR signals. First, this two-step communication

approach is inherently complicated, with potential for disruption due to the need to establish and reliably maintain two communication links. Second, there is a risk that the manufacturer could stop supporting the cloud interface, breaking the communication interface and disabling the DR functionality. There may be similar challenges for proprietary communications, including restrictions on use and licensing fees.

- Potential solution: while there is little that can be done to prevent a manufacturer from choosing not to support DR functionality, requiring compatibility with open communications standards can limit the restrictions and usage fees that a manufacturer could impose on the use of cloud-based controls. Utilities with a strong preference for device-based VENs may consider making this a requirement for DR program participation.

DR CAPABILITIES OF VARIABLE-CAPACITY ROOFTOP PACKAGED UNITS

DR for VC rooftop packaged units is primarily initiated using a control signal from the building EMS. The control signal resets the zone air temperature setpoints, to reduce unit energy consumption during utility peak demand periods. In many cases, the temperature setpoint change is implemented immediately at the beginning of the DR event, and is allowed to immediately return to the original setpoint temperature once the demand event has ended. At least one manufacturer provides the flexibility to transition the setpoint temperature as a user-defined rate of change (for example, degrees per hour) which is applied at the beginning and end of the DR event.

Several equipment manufacturers indicate they are actively working to develop improved DR control methods for their units. These methods focus on taking advantage of variable controls, improved part-load performance, and extensive on-board measurements built into their systems. However, specific details regarding their efforts and timetable are not available at this time.

MARKET STUDY OF AUTO-DR CAPABILITIES OF VRF TECHNOLOGY

The DR capabilities of VRF technologies are detailed in a 2017 market characterization report submitted to SCE [12]. The study noted that nearly 1,000 VRF units were incentivized by SCE and PG&E between 2010 and 2016, and sales were expected to grow at about 11% annually through 2018. This study reports on interviews conducted with manufacturers in August and September 2016 regarding equipment capabilities, and provides context on code requirements – primarily California Title 24, described below.

Overall, the study finds that VRF systems do not have built-in Automated Demand Response (Auto-DR) functionality, but some VRF controls could be used in load-shed strategies, including the ability to turn off specific indoor zones, change temperature setpoints, limit compressor demand, or reduce fan speeds. A few manufacturers have the capability to control zones in groups, provide soft-start ramping of compressors (for demand limiting), and integrate feedback from power metering. Yet most manufacturers cannot dispatch a temperature set-back command to the entire

system from the central controller, perhaps the most basic of DR strategies. Moreover, no product has a specific notice that is displayed during DR events.

To participate in SCE's ADR programs, a VRF system must receive DR event notifications via OpenADR 2.0, requiring a VEN to be integrated into the controller software. There are three basic strategies to accomplish this:

- 1) Embed the VEN into the VRF central controller.
- 2) Connect the VRF central controller to a third-party VEN.
- 3) Connect the VRF central controller to an EMS with embedded VEN.
- 4) Use a web-based VEN that communicates the DR event response to the VRF system.

No manufacturer was found to offer any of these solutions with commercially-available products, although several were in development. One manufacturer was reported to be developing a solution based on Strategy 1, namely by integrating a VEN into its central controller. This was expected to be released in 2018. Another manufacturer was found to be developing a solution using Strategy 2 by partnering with a third party to integrate its external VEN with their central controller. Each of these first two development efforts is attributed to Pacific Gas and Electric (PG&E) and SCE incentive programs for DR with VRF (both programs have since expired). Lastly, another equipment manufacturer takes the third approach by integrating a VEN into its own EMS solution, but this approach requires custom programming to achieve Auto-DR functionality and is not OpenADR certified. Moreover, at an estimated cost of \$15,000, this solution was not found to be a cost-effective method.

The most relevant regulatory code in this area is the CPUC's Title 24 Building Energy Efficiency Standards for Residential and Nonresidential Buildings [13]. With respect to DR, Title 24 requires multi-zone systems with Direct Digital Control (DDC) to the zone level to support automated demand shed control of all non-critical zones. These controls are required to have the ability to adjust temperature setpoints by at least 4°F in response to a DR signal in both heating and cooling modes (to increase setpoint in cooling mode and decrease it in heating mode). The study found that while several manufacturers were developing this functionality, only one had piloted it, and the function was not yet built into its available VRF systems.

Moreover, Title 24 requirements for thermostats specify the ability to program setpoints at 85°F or higher in cooling mode, and 55°F or lower in heating mode, with a deadband of at least 5°F. The study found all manufacturers satisfied the cooling requirement, three of seven met the heating requirements, and all effectively met the deadband requirement, since VRF systems are able to reduce compressor speed to a minimum (or turn off) between heating and cooling setpoints.

Overall, the study found VRF systems have controls that allow manual demand reduction strategies, but none are sufficiently integrated to enable automated response. For this reason, the authors concluded no VRF product fully complies with Title 24 requirements for DR or thermostats. Two primary causes were identified: first, manufacturers have not been proactive in investing in developing these functions until they receive clear market signals demanding these features from their customers. Second, the manufacturer interviews highlighted their lack of familiarity with the specifics of state code requirements, despite their desire to prioritize code compliance.

Table 2 summarizes the readiness of DR features found for each manufacturer evaluated in the study.

TABLE 2: SUMMARY OF ADR-READINESS BY MANUFACTURER IN 2016

	A	B	C	D	E	F	G
OpenADR 2.0b support	Pending	EMS	Partnered VEN	*	*	*	*
Demand limit from central controller	Y	Contact closure	Y	Y	Contact closure	Manual only	Contact closure
Group zones from central controller	Y	EMS	Y	Y	EMS contact closure	Y	EMS
Built-in DR command interpretation	Pending	N	Pending	Pending	N	N	N
DR control over standard VRF communications network	Pending	Y	Y	Y	N	N	Pending

In the study's conclusion, the authors recommended verifying a minimum set of ADR functions for VRF systems. These basic functions include: support for OpenADR 2.0b, demand limit controls from the central controller, ability to group zones at the central controller, built-in DR command interpretation (without external VEN), and the ability to send VRF controls over the standard VRF communications network. In addition, the study encouraged SCE to continue engaging the market through education and incentives, given the fact that utility incentives were cited as a motivation for developing ADR functions in the first place. Moreover, it was recommended that SCE continue ADR pilot programs, to continue further development of these features. One final recommendation was to offer support to manufacturers in troubleshooting communications with SCE's OpenADR server. Despite the open nature of this communication standard, enough differences exist between utility interpretations to cause issues in connecting to SCE's DR program.

DEVELOPMENT OF ADVANCED DR CAPABILITIES

Over the course of this current project, EPRI leveraged its relationships with HVAC manufacturers to understand their products' capabilities, and engage them in developing advanced DR functionality that benefits from their most efficient products' variable-capacity. Technical discussions were conducted with Manufacturers A, B, and F. When these discussions first began, the manufacturers were found to have limited experience with advanced DR approaches (such as capacity limiting) or open communications standards (such as CTA-2045 or OpenADR) and few of their products supported open communications. However, all manufacturers expressed a desire to better understand DR requirements and communications to satisfy energy code (notably California Title 24) and improve their products' capabilities.

To date, one approach to define specific DR responses that use variable-capacity equipment capabilities was developed by AHRI through AHRI Standard 1380 (2019). This standard, developed with input from many industry stakeholders, applies to residential and light commercial systems (of less than 5.4 tons capacity) that are either fully or discretely variable (for example, two-stage) and defines demand shed

events in terms of a Capacity Limit function, in place of traditional approaches to limiting HVAC demand (such as temperature setpoint offset and duty cycle control). For instance, the General Curtailment function specified in AHRI 1380 limits system capacity to no more than 70% of nominal power, subject to a maximum indoor temperature change with respect to the setpoint, which can be defined by the DR program administrator. The system will not be able to operate above this power level, as long as the indoor temperature does not exceed the specified deviation. The standard also indicates how these functions are to be mapped to open communications protocols. This standard, while voluntary, provides a common approach for DR control strategies that take advantage of VC system capabilities and establish the control functionality outlined in this project.

EPRI believed it was best to leverage the DR functions and open communication protocols already defined in AHRI Standard 1380, instead of starting from scratch to map DR commands to responses from light commercial, variable-speed HVAC equipment. Manufacturers may already be in the process of implementing the 1380 requirements in their residential, variable-speed products, so they may already be familiar with those communications and DR signals. We made two major additions to the VRF system evaluated in this project. First, AHRI 1380 defines three specific curtailment levels for systems targeting residential and light commercial applications. For this project, another variable was passed to the system, to specify the curtailment level (fractional value, 0-1) since the variable-speed systems should be able to meet a range of curtailment levels instead of only three specific levels. The second major change was to add a “load up” function, in which the HVAC system is asked to increase power consumption during periods of inexpensive electricity costs or during periods when electricity generation from photovoltaics is high. Details of the full set of DR functionality implemented for the VRF system are provided in the next section of this report.

Based on the technical maturity of their products, their ability to support novel controls solutions development, and the availability of suitable field sites in host utility territories, Manufacturers A and B agreed to participate in the project. Over the course of this project, EPRI worked with each of these manufacturers to develop and enhance their advanced DR controls with variable HVAC.

VRF EQUIPMENT CONTROLS

Specifically for this project, Manufacturer B assigned a controls engineer to develop custom control logic for their VRF equipment, to implement an advanced DR strategy with the intent of adopting a mature version into one of their commercially-available products. They loaded code into the manufacturer’s integrated building management and controls platform, which is marketed to provide some of the functionality of a Building Management System (BMS) for light commercial buildings with their VRF product. This controller supports multiple building automation protocols (Modbus, BACnet, and LonWorks) and includes cellular communications for remote management. While this controller has more capabilities (and additional cost) than needed to accomplish the DR strategies in this project, it was selected to allow flexibility in algorithm development.

To assist with initial testing, the engineer included the ability to monitor and dispatch DR controls via the Graphical User Interface (GUI) available through the controller, as shown in Figure 3. This interface allowed EPRI researchers to observe the VRF system’s overall status and response to DR events, as well as each zone on the VRF

system, its operating mode, and the setpoints and measured indoor air temperature for each zone.

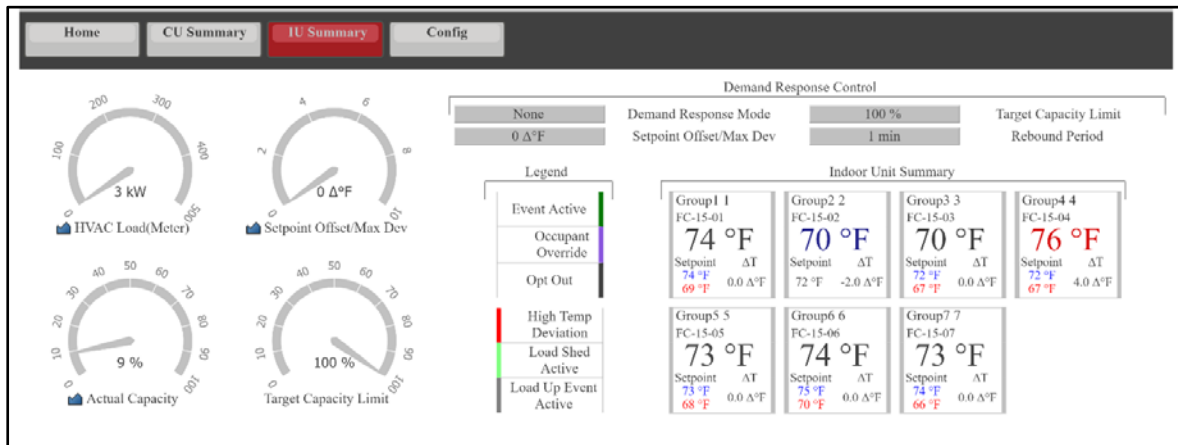

FIGURE 3: MFG. B VRF EQUIPMENT CONTROL GUI

In addition, Manufacturer B added support for OpenADR (version 2.0b) and configured the controller to communicate with EPRI's OpenADR VTN server. This allowed test events to be scheduled using OpenADR, similar to the way events in a utility's DR program would be initiated.

For this project, equipment controls were added to support the following DR functions:

1. Compressor (capacity) limit – similar to AHRI 1380, limits overall system capacity while indoor temperature is within an allowed range, specified by an "Allowed Temperature Deviation" variable that can be set for each event. The capacity limit target is a variable passed via OpenADR 2.0b. For example, when a 50% compressor limit event is called, the unit is limited to no more than 50% of its nominal capacity, as long as the indoor temperature remains within the Allowed Temperature Deviation, which can be set as the average of all zones or the maximum of any single zone. As the indoor temperature exceeds the allowed deviation, the capacity limit is lifted at a rate of 20% per °F, letting indoor conditions return to within the allowed range.
2. Setpoint offset – applies a specified temperature offset (delta) to the setpoint to reduce load in all zones (for example, to increase setpoint in cooling mode and decrease it in heating mode). This function was included as a baseline for this conventional DR method.
3. Targeted capacity reduction – sheds (disables heating/cooling) in indoor zones in order, or by lowest priority (predefined by the user) to satisfy the capacity reduction target (for example, 50% reduction) using each indoor zone's nominal capacity to estimate the required reduction.

4. Load up – applies a specified temperature offset (delta) to the setpoint, to increase load in all zones (for example, decrease setpoint in cooling mode and increase it in heating mode).

For the VRF equipment evaluated in this project, capacity could be limited in discrete steps based on the number of ODU “modules”, as defined in Table 3. If an event specifies a capacity limit that is not one of the available increments, the controller rounds up the limit to the next available step (for example, a limit of 60% will round up to a 75% limit for single-module systems, since that is the next available increment).

TABLE 3: AVAILABLE CAPACITY LEVELS

Single Module (up to ~12 tons)	Twinned Modules (roughly 14-20 tons)	Tripled Modules (Over 20 tons)
100%	100%	100%
75%	88%	92%
50%	75%	84%
0%	63%	75%
	50%	67%
	38%	59%
	25%	50%
	0%	42%
		34%
		25%
		17%
		0%

Table 4 shows how these functions were mapped to standard OpenADR 2.0 signals for testing in this project.

TABLE 4: OPENADR 2.0 VRF EQUIPMENT ADVANCED DR CONTROLS MAPPING

Function Name	Signal Name	Signal Type	Payload	Notes
Compressor Limit	simple*	level	1	
	LOAD_CONTROL	x-loadControlLevelOffset	Int, °F	Allowed Temp Deviation
	LOAD_CONTROL	x-loadControlCapacity	0.0 – 1.0	Fraction of ODU rated power
Setpoint Offset	simple*	level	2	
	LOAD_CONTROL	x-loadControlLevelOffset	Int, °F	Temp Offset
Targeted Capacity Reduction	simple*	level	3	
	LOAD_CONTROL	x-loadControlLevelOffset	Int, °F	Allowed Temp Deviation
	LOAD_CONTROL	x-loadControlCapacity	0.0 – 1.0	Fraction of ODU rated power
Load Up	simple*	level	0	
	LOAD_CONTROL	x-loadControlLevelOffset	Int, °F	Temp Offset

For each of these event types, a recovery period can be defined to gradually release the system to full capacity, to mitigate “rebound” or “snapback” effects. For Capacity Limit events, system capacity is ramped up linearly over the recovery period (specified in minutes via OpenADR 2.0b communications) and for Setpoint Offset events, the offset is linearly reduced over the recovery period.

RTU CONTROLS

Manufacturer A offers a cloud-based interface to remotely manage and control its equipment, including RTUs, through a cellular gateway installed as an upgrade to the standard unit (this typically requires an annual subscription, which was waived for testing purposes). Figure 4 shows the unit Overview tab in the GUI. The interface allows unit status and setpoint monitoring, recorded data trending, and alarm codes. In addition, Manufacturer A offers an upgrade to measure the unit’s three-phase power, which can also be viewed through their cloud interface.



FIGURE 4: MFG. A RTU CONTROL GUI

Demand shed commands could be manually set through this GUI under its Controls tab. These controls do not allow scheduling events or support any DR communications standards. Manufacturer A is considering adding DR communications and appropriate equipment responses, but that functionality was not available for this project. Figure 5 shows the Demand Shed controls. This unit only supported Temperature Setpoint Offset mode, but allowed the offset to be applied as a step change or with some ramp rate (in °F/h), which was applied to the start and end of the event, allowing some recovery control after a DR event. EPRI suggested this ramp only be applied to the end of the event for smooth recovery, with an immediate step change at the beginning of the event to ensure load shed, but this was not yet implemented at the time of testing.

Demand Shed	
Network Demand Shed En:	Manual <input type="button" value="v"/>
Cooling Shed Incr (d°F):	2.0 <input type="button" value="-"/> <input type="button" value="+"/> <input type="button" value="v"/>
Heating Shed Incr (d°F):	2.0 <input type="button" value="-"/> <input type="button" value="+"/> <input type="button" value="v"/>
DemandShed:	Enable <input type="button" value="v"/>
Cooling Shed Rate (°F/h):	2 <input type="button" value="-"/> <input type="button" value="+"/> <input type="button" value="v"/>
Heating Shed Rate (°F/h):	2 <input type="button" value="-"/> <input type="button" value="+"/> <input type="button" value="v"/>
<input type="button" value="Send Message"/> <input type="button" value="Save Changes"/> <input type="button" value="Reset"/>	

FIGURE 5: MFG. A RTU DEMAND SHED CONTROLS

This RTU could also provide the same setpoint temperature changes if connected to a BMS or EMS. When a facility uses an EMS, there are many opportunities to coordinate equipment operation and respond to DR events. However, there is a large number of small commercial buildings that are unable to justify EMS cost, so our focus was to understand the current remote access capabilities and encourage Manufacturer A to offer standardized, predictable responses when the equipment directly receives DR messages via an open communications protocol.

TECHNICAL APPROACH

This section covers the project team's technical approach, including assessment objectives, instrumentation plan, selected field sites' characteristics, and planned test matrix.

ASSESSMENT OBJECTIVES

The study objectives were to show the capabilities of VC HVAC to provide DR by demonstrating emerging controls approaches at Southern California field sites, and to evaluate their response in terms of demand reduction, impact to occupant comfort, and potential to manage recovery.

INSTRUMENTATION PLAN

To verify system response and performance, the project team installed monitoring equipment to independently confirm the systems' electrical, thermal, and environmental conditions.

ELECTRICAL PARAMETERS

The following electrical parameters were measured with revenue-grade monitoring equipment: voltage (V), current (A), power (kW), energy (kWh), and power factor. These parameters were collected throughout testing, including baseline and DR events from all the tested IDUs and ODU.

THERMAL PARAMETERS

The following parameters were measured to characterize the thermal load and operating conditions that impact HVAC system performance:

- Indoor air temperature (°F) in each zone, measured near the unit's thermostat
- Outdoor air temperature (°F) near the ODU at each site

INSTRUMENTATION

The following equipment was used for monitoring and data collection throughout the project:

- Power meters (revenue grade)
- Current Transformers (CTs)
- Air temperature and humidity sensors (duct, probe, and outdoor models)
- Data acquisition server
- Remote sensor input/output module
- Cellular modem

Data acquisition server was the primary device to collect and record measurement data from the monitoring equipment at each site. These devices were configured to

collect measurements at one-minute resolution. They stored recent data in onboard memory uploaded to a secure EPRI database server every eight hours, over a Virtual Private Network (VPN) via an encrypted cellular connection. Several failsafe algorithms and security features were implemented in the software, to ensure data retention and security. None of the collected data points included any Personally-Identifiable Information (PII), and researchers made every reasonable effort to maintain building occupant and exact site location privacy.

SENSOR AND POWER METER ACCURACY

Table 5 lists the accuracy of the sensors and monitoring equipment used in this study.

TABLE 5: MONITORING EQUIPMENT ACCURACY

MONITORING EQUIPMENT	ACCURACY
Power meters	<0.2% @ 25°C
Current transformers	±0.75% and ±0.2%
Temperature sensors	±0.3°C @ 25°C and ±1% (1°C or 1.8°F) @ 25°C
Humidity sensors	±2% 10-90% RH @ 25°C and ± 3% (10-90% RH)

FIELD SITE CHARACTERISTICS

Selected field sites represented typical building types and climate zones in SCE's territory. Since VC equipment is not widely adopted, two sites known to have this equipment installed were considered for inclusion. The two sites were good representatives of where variable-speed equipment was installed to serve a portion of each building. One site was owned by SCE, and we had an existing relationship with the other site administrator due to prior testing at their location.

SITE 1 CHARACTERISTICS

We selected SCE's Irwindale Energy Education Center (EEC), after carefully considering several sites that had suitable Manufacturer B VRF equipment. The EEC is located in California Climate Zone 9 (Southern California inland valley, represented by the City of Pasadena). An eight-ton heat recovery VRF system served three offices and a conference room. This system has three additional IDUs installed for demonstration purposes, which are located in an adjacent high-bay space served by a separate RTU. Figure 6 shows the layout of the VRF system and EPRI temperature sensors at Site 1, including the ODU and all connected IDUs: Office 1, Office 2, Conference Room, Office 3, and three additional demo units.

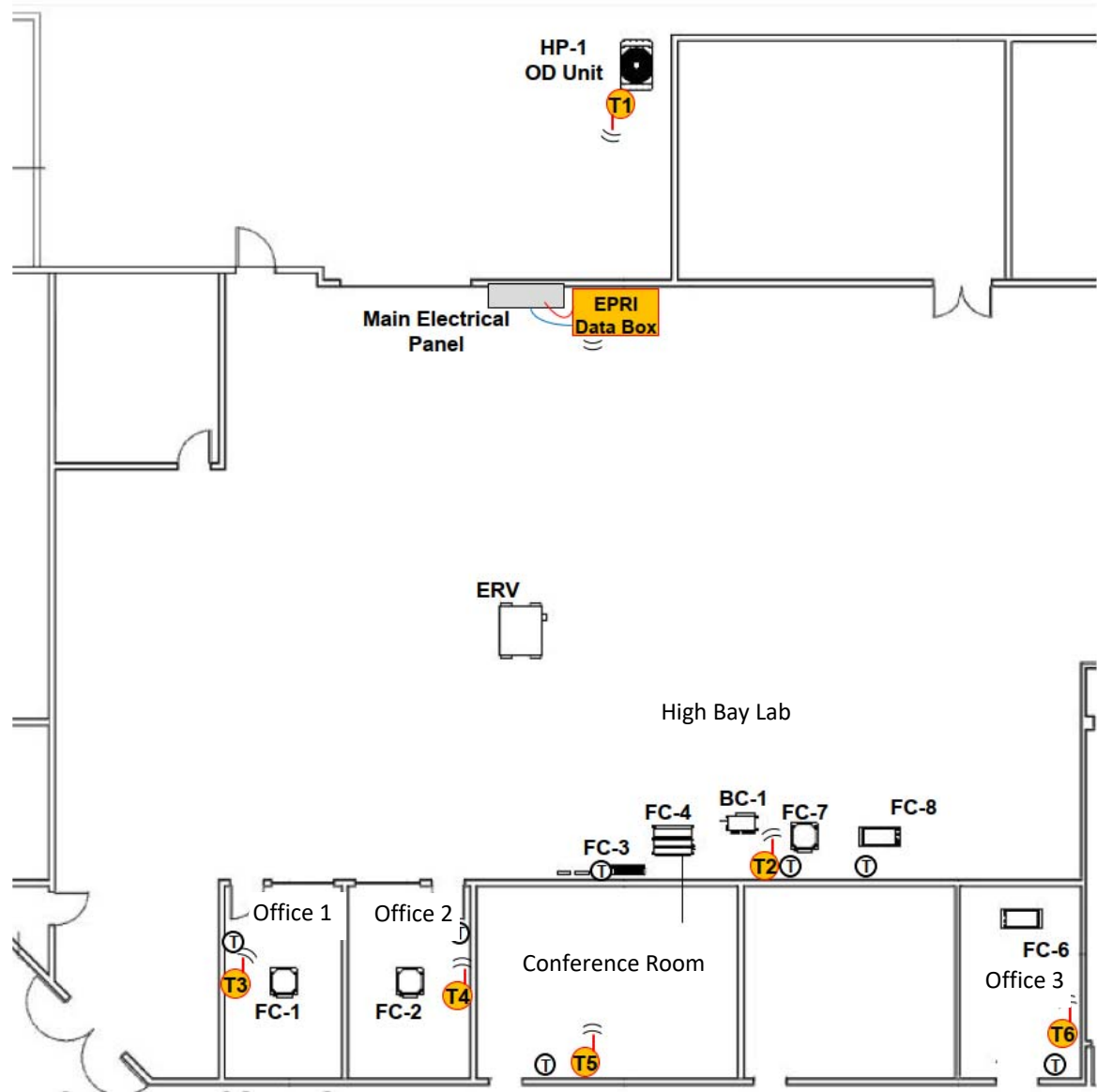

FIGURE 6: SITE 1 DIAGRAM SHOWING VRF SYSTEM AND MONITORING EQUIPMENT

Test 1 indicated the VRF system was lightly loaded, demonstrated by the ODU cycling off and on at minimum power, even during the heat of the day (high temperature = 94°F). Figure 7 shows a stacked bar chart of IDU and ODU power, with reference lines for 50% and 100% of rated capacity (the ODU's nominal power is 7.0 kW, and the IDU operated at an average of 760 W).

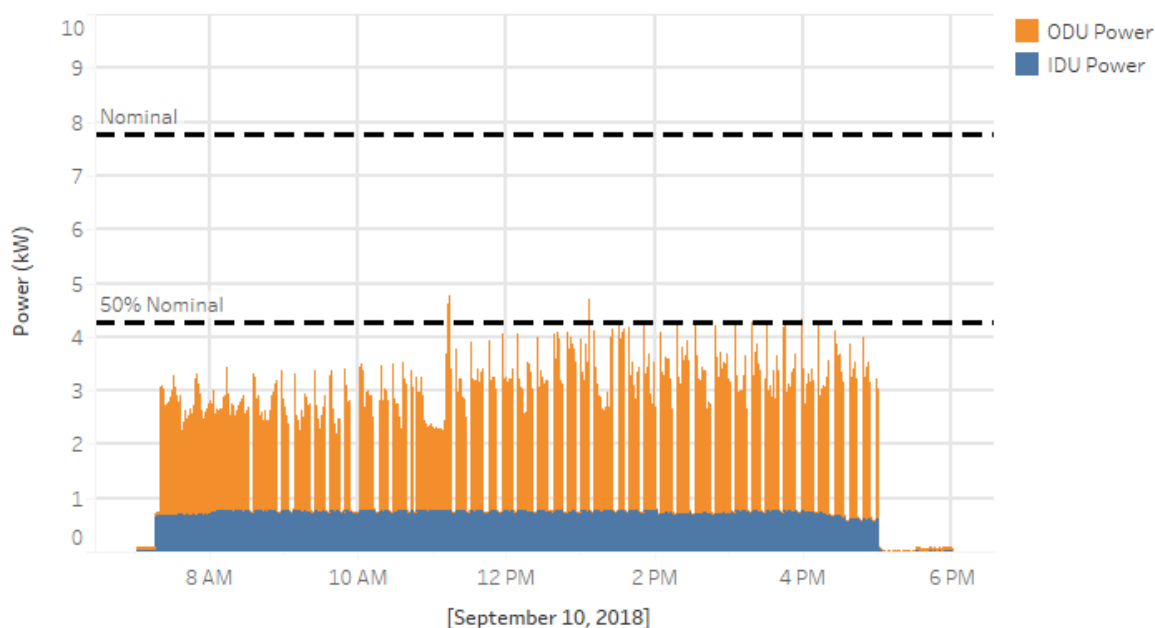

FIGURE 7: TEST 1 AT SITE 1

To increase load on the VRF system, the three demonstration units in the high-bay lab space were set on high fan speed to cool to 72°F, and the RTU's setpoint was increased to 76°. This was to load the unit more fully so it would operate continuously at more than 50% of its nominal capacity during typical summer days. Since the total VRF system capacity was eight tons, it could only be limited to four stages: 0%, 50%, 75%, and 100%, as noted in Table 3.

Table 6 lists the indoor zones the VRF system conditioned at Site 1, with the nominal cooling capacity (in Btu/h) and IDU type listed for each. The total capacity of all connected IDUs was 77,000 (Btu/h). The system was designed to accommodate an additional zone rated up to 36,000 Btu/h (three tons).

TABLE 6: SITE 1 (IRWINDALE) CHARACTERISTICS

ZONE	AREA	RATED CAPACITY (BTU/H)	IDU TYPE
1	Office 1	8,000	Four-way cassette
2	Office 2	8,000	Four-way cassette
3	Office 3	15,000	One-way cassette
4	Conference Room	24,000	Ducted
5	Demo unit 1	8,000	Ductless
6	Demo unit 2	8,000	Four-way cassette
7	Demo unit 3	6,000	One-way cassette

The VRF system ODU had a nominal cooling capacity of 96,000 Btu/h (eight tons). The ratio of connected IDU to ODU capacity was 80%, well within Manufacturer B's allowed range (50% to 130% for this unit).

SITE 2 CHARACTERISTICS

We selected a school in the city of Simi Valley for Site 2, since it had been used previously to test a Manufacturer A variable-speed RTU, and EPRI monitoring was already in place. This three-ton air-conditioning unit served a single elementary school classroom. The site is located in California Climate Zone 9 (Southern California inland valley, represented by the city of Pasadena).

Figure 8 shows the Site 2 RTU evaluated in this study. The unit has horizontal ductwork for supply and fresh air intake, and vertical ductwork for return air (located under the unit and not visible in these photos).



FIGURE 8: SITE 2 RTU

Figure 9 shows the Site 2 monitoring equipment layout. Airflow monitoring had been installed as part of the prior project, but it was not used for this project, since a detailed delivered cooling capacity analysis was not required.

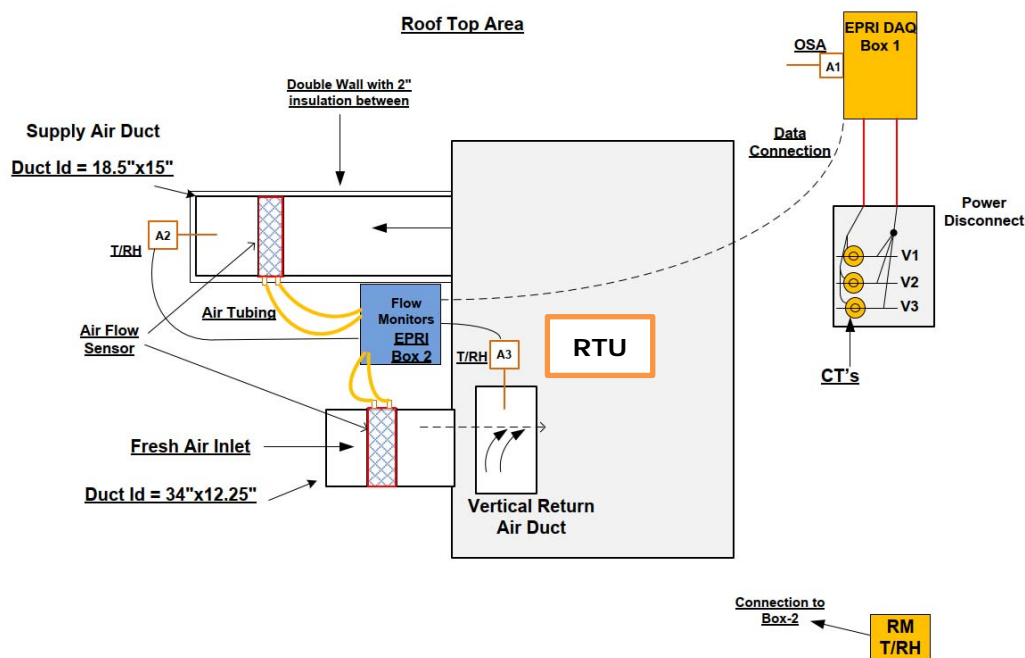

FIGURE 9: SITE 2 INSTRUMENTATION LAYOUT

TEST MATRIX

A test matrix was developed for each field site to evaluate the available DR functions with a range of control parameters. Test events were timed to coincide with peak cooling load on the systems, keeping each space's occupancy patterns in mind. For example, Site 1 was consistently occupied from 8 a.m. to 4 p.m. (the VRF was scheduled to operate from 7 a.m. to 5 p.m.) so test events were selected for the event and recovery period to be concluded by 4 p.m. Figure 10 shows the Site 1 VRF system's typical operating profile on a baseline day (when loaded up as described earlier).

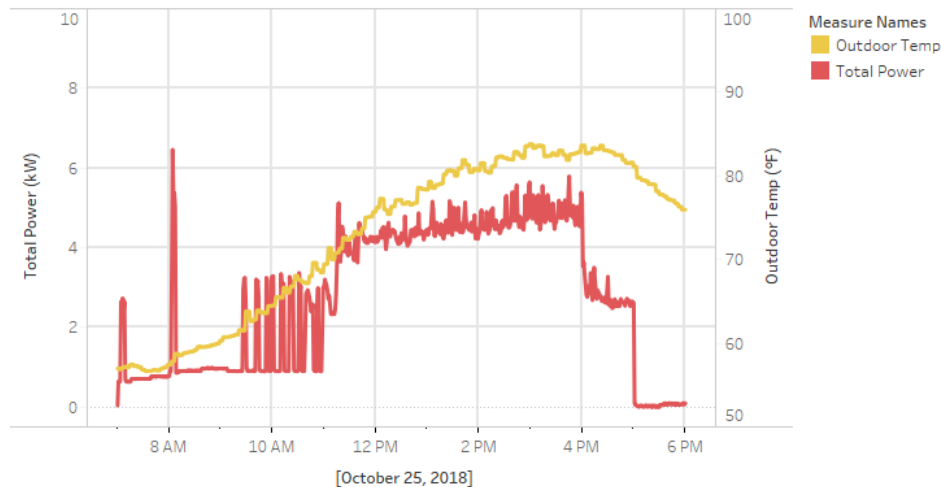

FIGURE 10: SITE 1 TYPICAL OPERATING PROFILE (BASELINE SUMMER DAY)

The Site 2 unit served a classroom that dismissed at 3 p.m., although the unit did not operate on a fixed schedule and often ran into the evening. Figure 11 shows the Site 2 RTU's typical operating profile on a hot baseline day. The indoor fan operated continuously at about 150 W.

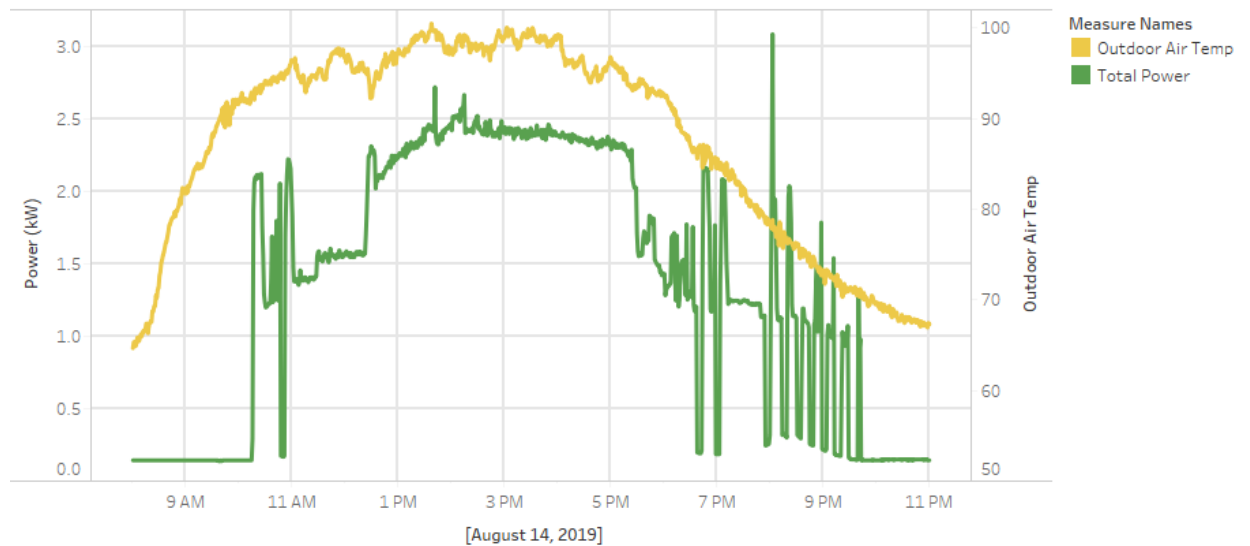

FIGURE 11: SITE 2 TYPICAL OPERATING PROFILE (BASELINE SUMMER DAY)

It was important to test a range of DR event types, event lengths, offset temperatures, and recovery period configurations to evaluate equipment response under different parameters. The four functions included Capacity Limit, Temperature Setback, Precooling followed by Capacity Limit, and Targeted Capacity Reduction. Offset temperatures ranged from 1°F to 3°F, with 30- and 60-minute recovery periods tested. Initial events were intended to confirm basic functionality and system response. Each test matrix was subject to revisions based on earlier test results. Table 7 lists Site 1 VRF system test events.

TABLE 7: SITE 1 (IRWINDALE) TEST MATRIX

TEST	FUNCTION	TIME	LIMIT	OFFSET	RECOVERY
1	Capacity limit*	1-2pm	50%	2°F (max)	–
2	Capacity limit	1-2pm	50%	2°F (max)	–
3	Capacity limit	1-3pm	50%	1°F (max)	–
4	Temperature setback	1-3pm	–	2°F	–
5	Capacity limit	1-2pm	50%	3°F (max)	30-min
6	Temperature setback	1-2pm	–	3°F	–
7	Temperature setback	1-3pm	–	2°F	–
8	Capacity limit	1-3pm	50%	2°F (avg.)	30-min
9	Temperature setback	1-2pm	–	3°F	60-min
10	Temperature setback	1-2pm	–	3°F	60-min
11	Temperature setback	1-2pm	–	3°F	60-min
12	Pre-cooling	12-1pm	–	-2°F (pre)	–
	Capacity limit	1-3pm	50%	+2°F (avg.)	60-min
13	Capacity limit	2-3pm	50%	3°F (avg.)	60-min
14	Capacity limit	1-3pm	50%	3°F (avg.)	60-min
15	Targeted capacity reduction	1-2pm	50%	2°F (avg.)	–

*System lightly loaded in initial test.

Site 1 VRF initial testing indicated it was lightly loaded, demonstrated by the ODU cycling off and on at minimum power even during the heat of the day (high temperature = 94°F). Load was added to the system after the initial test (as discussed above) so Test 1 was excluded from further analysis.

Table 8 lists successful Site 2 RTU test events. As noted above, only the Setpoint Offset function was available for testing this unit. The offset could be configured so it was immediately applied at the beginning and end of the event, or with a ramp rate in setpoint applied at the beginning and end of the event. Two offset values and event durations were selected to determine the impact on demand reduction and occupant comfort.

Due to challenges with the cloud-based dashboard (described below) multiple tests were attempted before system response could be confirmed. Also, after Test 3 was initiated, the controller rejected the specified 1°F/hr. ramp rate, indicating only values greater than 1 were accepted in this field.

TABLE 8: SITE 2 (SIMI VALLEY) TEST MATRIX

TEST	FUNCTION	TIME	OFFSET	RAMP RATE
1	Setpoint Offset	1-2pm	2°F	–
2	Setpoint Offset	1-3pm	2°F	–
3	Setpoint Offset	1-3pm	2°F	(1°F/hr.)*
4	Setpoint Offset	1-3pm	4°F	2°F/hr.
5	Setpoint Offset	1-2pm	4°F	–
6	Setpoint Offset	1-3pm	4°F	2°F/hr.

*Controller rejected 1°F/h ramp rate and instead applied a step change in setpoint.

RESULTS

Table 9 shows Site 1 VRF system test, and Table 10 shows Site 2 RTU test results. These tables provide a summary of DR test events at these sites over the course of the project, including test day details (date and high temperature) and DR functions tested. For Capacity Limit events, the maximum capacity and temperature offset are listed, which is interpreted by this VRF controller as the maximum allowed change in indoor temperature from prior setpoint. For temperature setpoint offset events (“temperature setback”) the temperature offset is listed. For VRF system tests, a recovery period is specified, which gradually releases the capacity limit or setpoint offset back to its original state after the DR event. For the RTU test events, a ramp rate was specified, to gradually ramp the setpoint offset at the beginning and end of the event. During Test 3, we determined the RTU controller would not accept a ramp rate of 1°F/hr.

As stated above, VRF system load was noted as low after analyzing initial data from Test 1, as shown by the system cycling at minimum power (Figure 7). After this point, VRF system load was increased for each test event by turning on the three demonstration units and increasing the setpoint of the RTU serving the high-bay lab space. To collect baseline performance data for comparison, the system was also run in the standard operating mode for a number of days, without any DR event, to provide several “baseline” data points.

METHODOLOGY FOR DR FUNCTIONALITY ANALYSIS

Each test event was matched with a baseline day (excluding weekends and holidays) that had similar weather before and during the DR event. The summary tables show the average system power for the entire VRF system (ODUs and IDUs) or the RTU for the entire DR event, compared with power at the same time on the baseline day. Demand shed is shown as a simple reduction in average demand (kW) during the DR event, and as a percent compared to the baseline demand. Complete test data is available in the Appendices.

SUMMARY OF TEST RESULTS

TABLE 9: SITE 1 (IRWINDALE) TEST RESULTS

TEST	DATE	OUTDOOR HIGH (°F)	DR FUNCTION	TIME	LIMIT	OFFSET	RECOVERY	ACTUAL DEMAND (kW)	BASELINE DEMAND (kW)	REDUCTION (kW)	REDUCTION (%)
1*	9/10/18	94°	Capacity limit	1-2pm	50%	2°F (max)	–				
2	9/17/18	94°	Capacity limit	1-2pm	50%	2°F (max)	–	4.2	5.3	1.1	20%
3	10/5/18	81°	Capacity limit	1-3pm	50%	1°F (max)	–	4.0	4.6	0.7	14%
4	10/12/18	86°	Temperature setback	1-3pm	–	2°F	–	4.2	5.3	1.1	20%
5	10/15/18	79°	Capacity limit	1-2pm	50%	3°F (max)	30-min	3.2	4.5	1.3	29%
6	10/23/18	81°	Temperature setback	1-2pm	–	3°F	–	2.1	4.5	2.4	54%
7	10/24/18	83°	Temperature setback	1-3pm	–	2°F	–	3.7	4.6	0.9	20%
8	10/26/18	91°	Capacity limit	1-3pm	50%	2°F (avg.)	30-min	4.3	5.5	1.2	22%
9	11/1/18	85°	Temperature setback	1-2pm	–	3°F	60-min	3.0	4.5	1.5	34%
10	11/8/18	77°	Temperature setback	1-2pm	–	3°F	60-min	1.3	4.5	3.2	71%
11	8/19/19	93°	Temperature setback	1-2pm	–	3°F	60-min	6.0	5.3	-0.7	-13%
12	8/29/19	96°	Pre-cooling capacity limit	12-1pm 1-3pm	– 50%	-2° (pre) +2° (avg.)	– 60-min	5.2	6.1	0.9	15%
13	9/16/19	90°	Capacity limit	2-3pm	50%	3°F (avg.)	60-min	4.5	6.1	1.6	26%
14	9/24/19	95°	Capacity limit	1-3pm	50%	3°F (avg.)	60-min	4.6	6.1	1.5	25%
15	10/2/19	87°	Targeted capacity reduction	1-2pm	50%	2°F (avg.)	–	5.8	5.2	-0.6	-11%

*System lightly loaded in initial configuration and should not be compared to other test events.

TABLE 10: SITE 2 (SIMI VALLEY) TEST RESULTS

TEST	DATE	OUTDOOR HIGH (°F)	FUNCTION	TIME	OFFSET	RAMP RATE	ACTUAL DEMAND (kW)	BASELINE DEMAND (kW)	REDUCTION (kW)	REDUCTION (%)
1	8/26/19	101°	Setpoint offset	1-2pm	2°F	–	2.3		-0.1	-4%
2	9/12/19	99°	Setpoint offset	1-3pm	2°F	–	2.3		1.0	45%
3	9/23/19	92°	Setpoint offset	1-3pm	2°F	(1°F/hr.)*	1.6		0.5	31%
4	9/24/19	104°	Setpoint offset	1-3pm	4°F	2°F/hr.	2.4	2.4	1.0	42%
5	9/25/19	104°	Setpoint offset	1-2pm	4°F	–	2.5	2.4	0.1	5%
6	10/7/19	97°	Setpoint offset	1-3pm	4°F	2°F/hr.	2.2	2.2	1.6	73%

*Controller rejected 1°F/h ramp rate and instead applied a step change in setpoint.

DATA ANALYSIS – SITE 1

Figure 12 shows an example of a successful test event using the Capacity Limit function with the VRF at Site 1 (for full test data, please refer to Appendix A). The test event is shown on the right, with a similar baseline day on the left. This event applied a 50% capacity limit to the VRF system from 1-3 p.m., allowing a 2°F rise in average zone temperature (system capacity was allowed to rise when the average “deviation” from setpoint in all zones exceeded 2°F). This was followed by a 30-minute recovery period, during which VRF system capacity was allowed to gradually rise. Total system power was held at 50% of nominal during the test event, and incrementally released after the event.

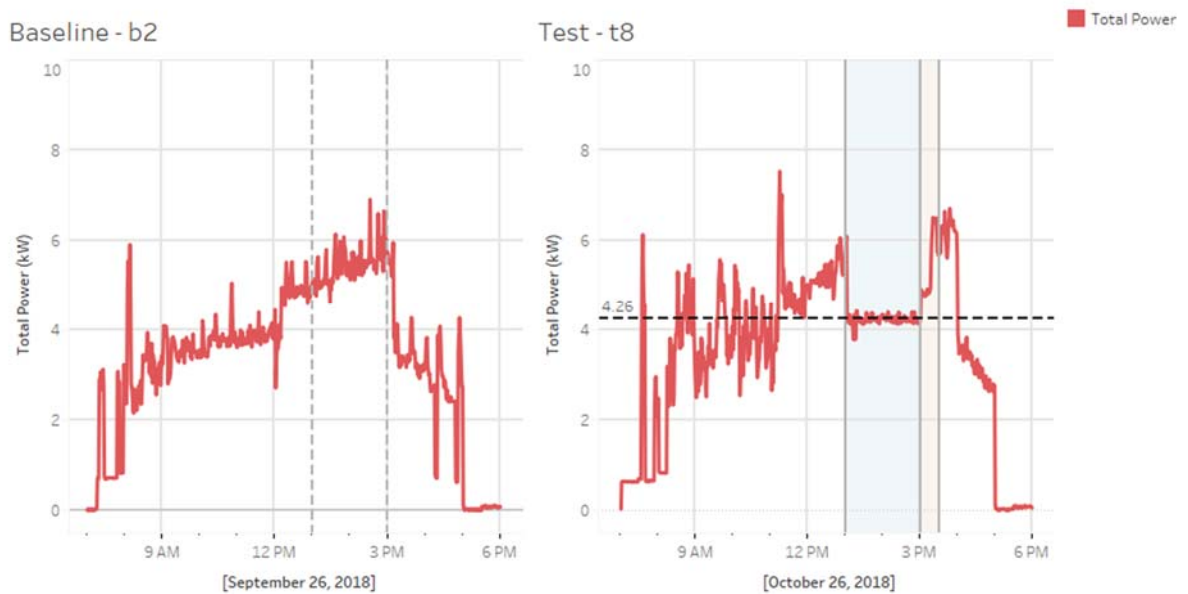

FIGURE 12: SITE 1 TEST EVENT DETAILS AND BASELINE COMPARISON – TEST 8 (CAPACITY LIMIT)

Figure 13 shows system response to a typical temperature setpoint offset event. A 2°F offset was applied from 1-3 p.m., with no recovery period (the high temperature on test day and the associated baseline day was 83°F). On this relatively mild day, total power was reduced by an average of 1.5kW during the two-hour DR period, compared to baseline data from the following day. For a similar test of this DR method with a much higher outdoor air temperature of 93°F and 3°F offset (Test 11), there was a 0.7 kW increase in power during the DR period. The impact of outdoor high temperatures on DR power reduction is described in Figure 16.

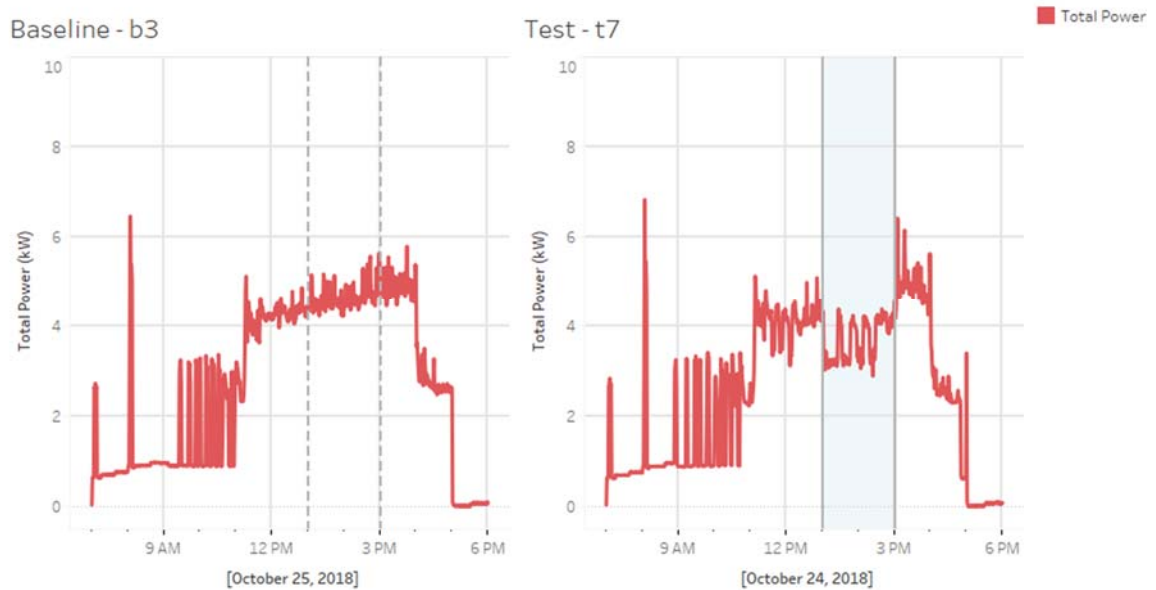

FIGURE 13: SITE 1 TEST EVENT DETAILS AND BASELINE COMPARISON – TEST 7 (SETPOINT OFFSET)

Figure 14 shows the Pre-Cooling event from 12-1 p.m., then limiting capacity from 1-3 p.m., followed by a 60-minute recovery period. Pre-cooling was achieved by decreasing the temperature setpoint of all zones by 2°F from 12-1 p.m., using the Load Up function provided by Manufacturer B. This was followed by a Capacity Limit event (limiting the system to 50% while average zone deviation was 2°F or less) followed by a 60-minute ramped recovery period. During this test, the average indoor zone temperature deviation exceeded the 2°F allowed, causing the controller to increase the capacity limit to the next available increment, 75%, for the duration of the test event. Most zones stayed within the 2°F allowed deviation, but an anomaly in one zone caused the average deviation to exceed 2°F.

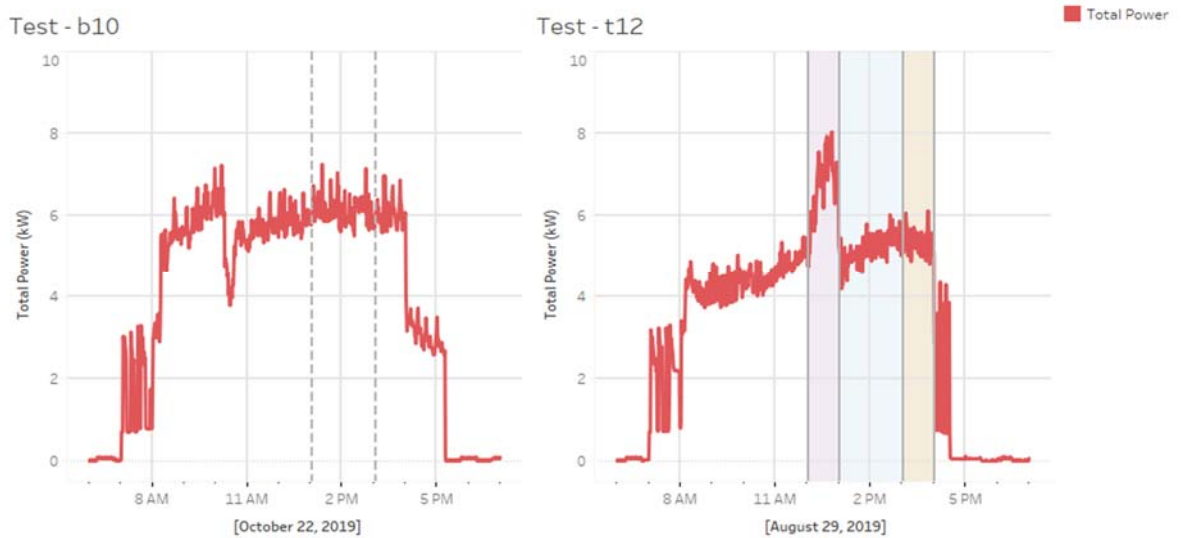

FIGURE 14: SITE 1 TEST EVENT DETAILS AND BASELINE COMPARISON – TEST 12 (PRE-COOLING)

Initial ramped recovery feature testing indicated it properly ramped capacity limits back up to 100% at the end of test events, as shown in Figure 12. However, testing with setpoint offset events showed the ramped recovery function did not correctly increment setpoints back to their previous values when the event was triggered with OpenADR communications. During Test 9, the setpoints were held at the offset value until the end of the recovery period, and for Test 10, the setpoints were reverted at the beginning of the recovery period. Figure 15 compares these two events, illustrating a clear change in system power when the setpoints were reverted. We confirmed this was an issue with OpenADR triggering, since manually-initiated events correctly ramped setpoints. After communicating with Manufacturer B, the issue was corrected, and Test 11 confirmed proper operation.

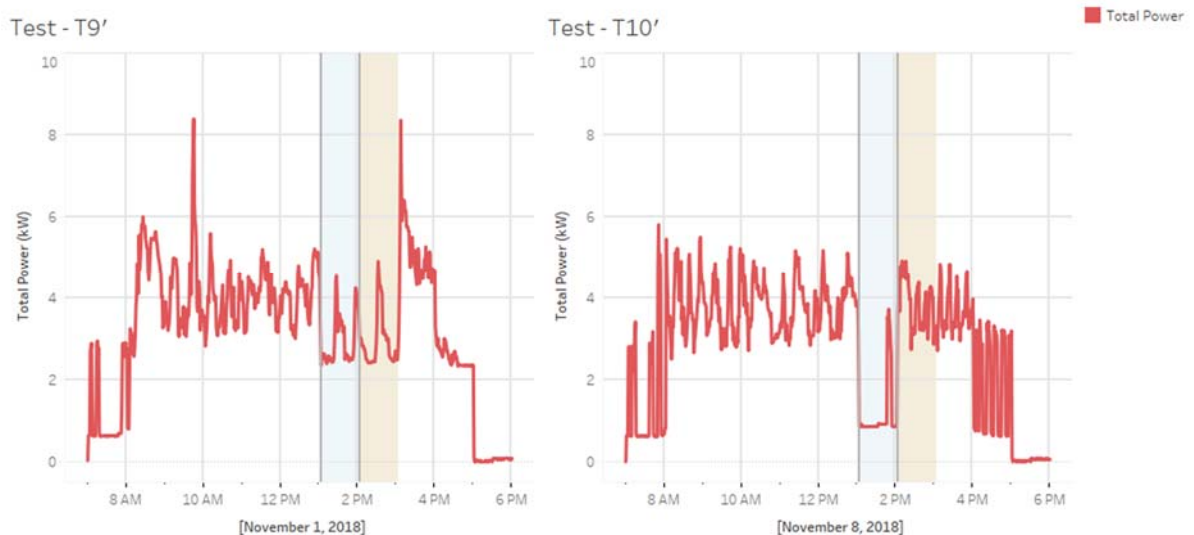

FIGURE 15: MIS-OPERATION OF RAMPED RECOVERY FOR TEMPERATURE SETBACK EVENTS AT SITE 1

We attempted one Targeted Capacity Reduction event at the end of the test period. This strategy sought to disable heating and cooling in zones, beginning in order from lowest priority, until the ODU load fell below the target level, in terms of percent of nominal capacity. For example, to meet a target of 50%, the lowest-priority indoor zones were disabled until only four tons of cooling was required (for the eight-ton Site 1 system). This was accomplished by putting zones into “eco mode”, in which occupants were notified by an icon on the indoor zone controller. When a zone reached the allowed deviation from setpoint, heating and cooling would be re-enabled, and the next-lowest priority zone would be disabled. However, occupants could not easily override eco mode. They were required to increase the setpoint temperature until the notification disappeared, which then indicated the zone could operate normally. For this reason, the strategy was not considered mature enough for repeated testing. It was attempted once with limited success (see Figure 35 in Appendix A) but since the system controller did not record the eco mode variable, researchers could not inspect system behavior in response to this strategy.

Figure 16 shows results from all Site 1 test events, plotting average demand shed (kW) over the event period versus the high temperature (outdoor air, °F) on test day. These colors indicate the control strategy: blue = Capacity Limit, orange = Setpoint Offset, gray = Pre-Cooling (followed by Capacity Limit), yellow = Targeted Reduction. The bubble size indicates event duration (one or two hours) and the label

shows the temperature offset. For Capacity Limit and Targeted Reduction events, the label shows the allowed temperature deviation from setpoint, with *a* indicating the deviation was calculated from the average of all zones, and *m* indicating the maximum of any one zone exceeding the allowed deviation would override the capacity limit.

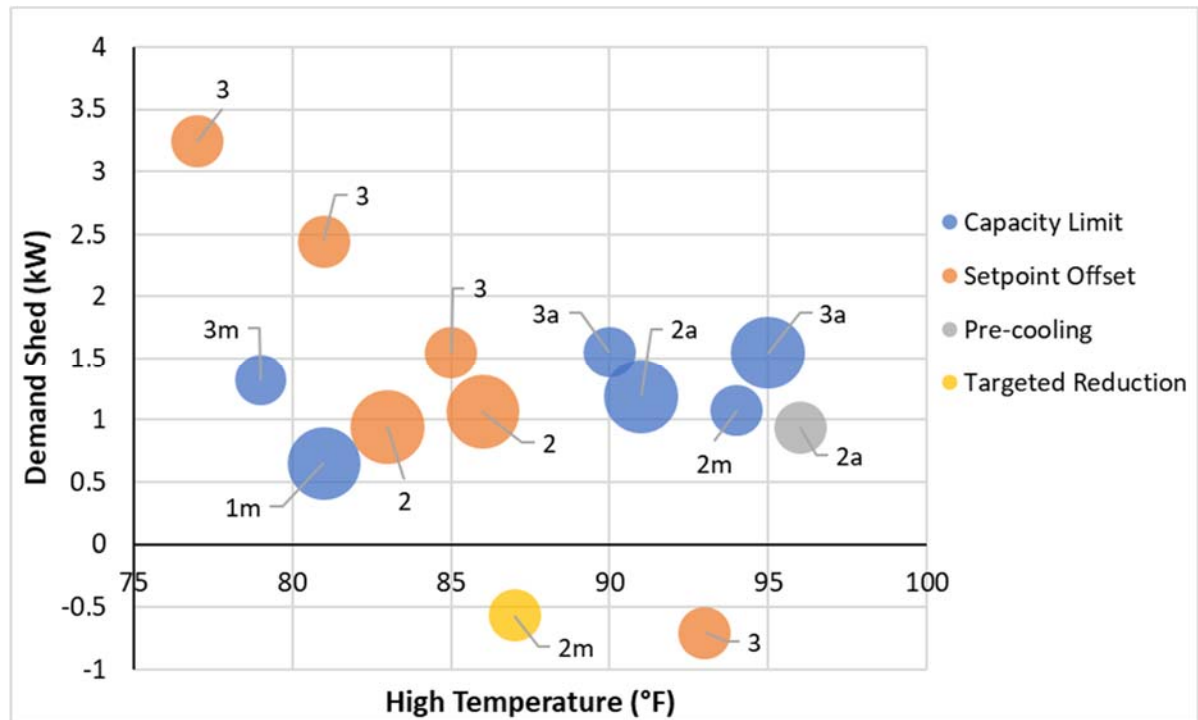

FIGURE 16: PLOT OF DEMAND REDUCTION FROM ALL TEST EVENTS AT SITE 1

For events on mild days, the Setpoint Offset control yielded the greatest reductions in demand over the test period. However, the hottest event with Setpoint Offset (Test 11) increased average demand over the period, compared to a similar baseline day. On the other hand, Capacity Limit had more consistent results on days with high outdoor temperatures, when DR events are normally called.

Figure 17 compares Capacity Limit control with Setpoint Offset, the baseline approach for DR with HVAC systems, on test days with high temperatures of around 91-93°F. Test 8 successfully limited system capacity to 50% from 1-3 p.m., while allowing a 2°F rise in average zone temperature. The Setpoint Offset control used in Test 11 appears to reduce system demand for a brief period as setpoints are raised 3°F at the beginning of the event, but quickly returns to its prior level as the indoor spaces reach their new setpoints (full test data is available in Appendix A, Figure 31).

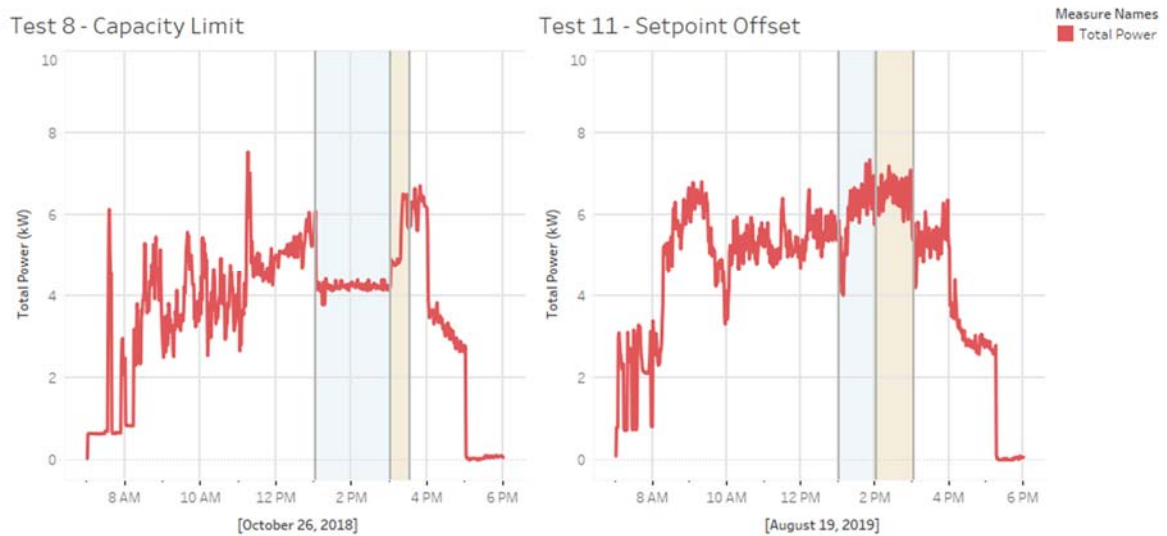

FIGURE 17: COMPARISON OF CAPACITY LIMIT AND SETPOINT OFFSET CONTROL AT SITE 1

DATA ANALYSIS – SITE 2

Site 2 testing presented several challenges. The RTU reported a number of communication and operation errors via its cloud-based technician dashboard. Most of these were cleared remotely, and did not impede testing.

The primary challenge was the dashboard, which we had to use in our testing because the unit did not support any open communications protocols. In particular, the cloud dashboard (accessed from a web page) exhibited substantial latency between control inputs and visual dashboard confirmation, with delays ranging from 10 minutes to more than an hour. Figure 18 shows the communication errors reported on the cloud dashboard.

Demand Shed

Network Demand Shed En: Inactive ✖ Request to Inactive failed (New value wait timeout)

Network Demand Shed Event: Inactive ✖ Request to Active failed (Communication error)

Cooling Shed Incr (d°F): 2.0 - +

Heating Shed Incr (d°F): 2.0 - +

DemandShed: Enable ▼

Cooling Shed Rate (°F/h): 3 - +

Heating Shed Rate (°F/h): 3 - +

Send Message
Save Changes
? Reset

FIGURE 18: COMMUNICATIONS ERROR WITH CLOUD DASHBOARD FOR RTU CONTROLS

Manufacturer A suggested these errors were not actually failures to communicate unit operational changes, but rather failures of the cloud controller to acknowledge and report a positive response from the RTU. This was attributed to delays in the server in processing communications about status from field units. In either case, this communications latency prevented researchers from confirming DR controls had been received, resulting in a number of failed test events. Moreover, this issue prevented any certainty in the timing of event actuation, because it was not known whether the delay was in the DR signal or in the RTU acknowledgement.

Figure 19 shows the typical Site 2 RTU response to a successful temperature setpoint offset event for a 2°F offset from 1-3 p.m. with no ramped recovery. The unit quickly ramped down (after a 14-minute delay) to fan only, despite the high outdoor temperature of 99°F (the nominal RTU power is 2.7 kW). Supply air fan-only operation continued, and the room air temperature rose for approximately 45 minutes out of the two-hour event. The unit then re-started operation to maintain the original setpoint temperature plus the 2°F offset for the remaining DR event hour. An optimized control algorithm may have used the variable-speed compressor to lower cooling when the setpoint temperature increased by 2°F, instead of shutting off completely then restoring power draw to the same level as before the DR event. The minimum compressor speed limit may have contributed to the unit cycling off.

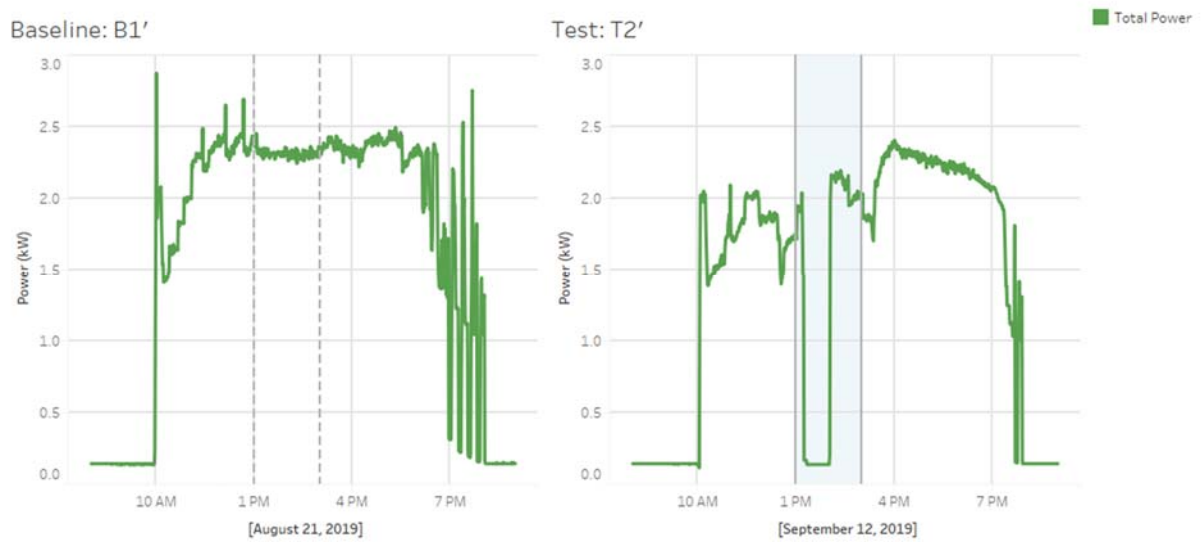

FIGURE 19: TEMPERATURE SETPOINT OFFSET AT SITE 2

Figure 20 shows the Site 2 RTU response to a temperature setpoint offset event with ramped recovery, which called for a 4°F offset from 1-3 p.m., with a 2°F/hr. ramp in setpoint at the beginning and after the end of the event. The unit ramped down to fan-only operation about 40 minutes after the DR command was sent, resulting in a power reduction of approximately 1.4 kW, which was maintained until the end of the two-hour DR event. During the recovery period, unit power initially spiked to over 2 kW for a few minutes, then settled back to roughly 1.5 kW, which was the level prior to the DR event. It is unclear whether the ramped setpoint rate was properly applied.

During testing, we discovered the setpoint ramp function would only accept values of greater than 1°F/hr. Please refer to Appendix B for complete test data.

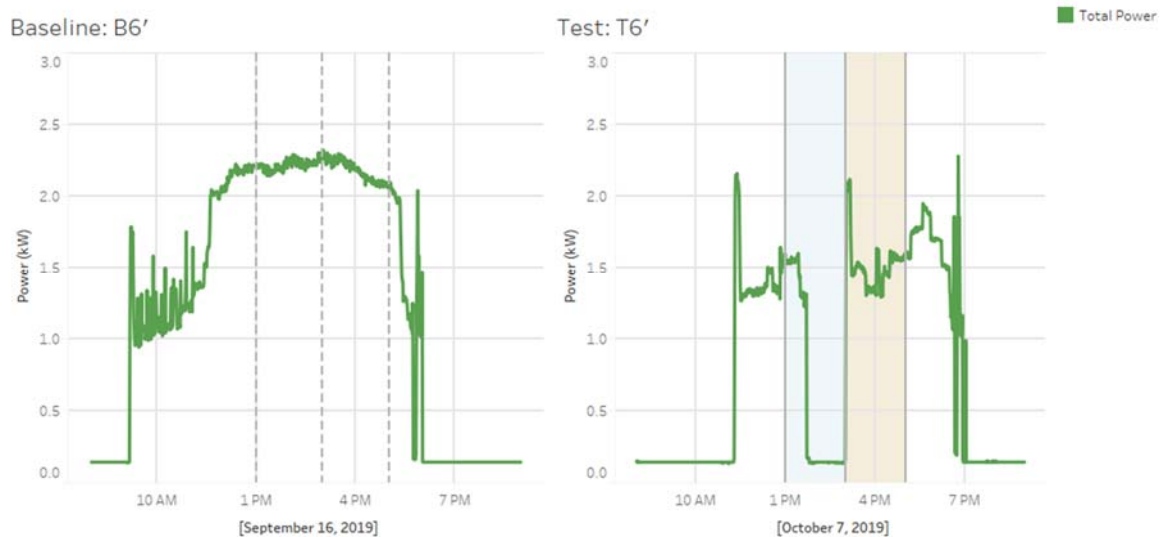

FIGURE 20: TEMPERATURE SETPOINT OFFSET WITH RAMPED RECOVERY AT SITE 2

CONCLUSION AND RECOMMENDATIONS

This project demonstrated advanced DR capabilities of VC HVAC equipment for commercial applications at two sites in Southern California: a VRF system in Irwindale (Site 1) and a variable-speed RTU in Simi Valley (Site 2). As part of this project, Manufacturer B, the VRF manufacturer, developed advanced DR controls that mimicked AHRI Standard 1380, which applies to equipment with less than 5.4 tons of cooling, along with additional capabilities (load-up function, percent capacity limit based on a numerical value included in the OpenADR message, etc.), including support for OpenADR 2.0b. The Site 2 RTU was tested under Temperature Setpoint Offset control only, using Manufacturer A's cloud dashboard for manual initiation of DR events.

We applied the Capacity Limit strategy to the VRF at Site 1 under a variety of allowed temperature deviations, considering the average deviation of all zones or the maximum deviation of any single zone, with and without a ramped recovery period, under multiple DR event and recovery durations. While the Temperature Setpoint Offset function yielded greater reductions in demand at mild outdoor temperatures, the Capacity Limit function provided more consistent reductions of about 1.0 to 1.5 kW (20 to 25%) at higher outdoor conditions for one-hour and two-hour event durations. Due to the VRF system size and low system cooling load, we were left with only one Capacity Limit (50%) that could be used to reliably reduce system demand.

Site 2 testing was limited, due to challenges using the cloud dashboard for DR control. In particular, the latency between sending commands and receiving acknowledgement was so long, we could not verify or trust that DR commands had been received or acted upon. Results indicate demand shed commands were received on multiple events after 15 to 60 minutes of delay, but with mixed results. The RTU did not take full advantage of its variable-speed capabilities for DR, and instead shut off in response to Setpoint Offset commands in several test events, much like a conventional single-speed system.

Findings from Site 1 VRF testing indicate the Capacity Limit strategy could reduce system demand, with minimal impact on indoor temperatures. Yet with only one manufacturer offering this function for commercial systems, its market potential is limited. A technical standard specifying the intended behavior and communications method could increase this approach's potential, if multiple manufacturers adopted it.

With positive results from Site 1 VRF testing, we recommend this technology be considered for a larger pilot to understand the impacts of broadly adopting it. For example, VRF field system sizing, loading, and network connectivity could impact performance in utility DR programs. More data on performance under restrictive limits and on hotter days would give insight to their full capabilities when impactful to DR programs. Manufacturer B recently integrated a control algorithm developed in this project into a less-expensive controller. It would be beneficial to confirm the new controller and its control algorithm produce the same (or better) VRF equipment DR response.

Lastly, an industry standard is needed for DR control algorithms that properly leverage VC equipment for these functions to be widely available. Such a standard would build upon AHRI Std 1380, which applies to systems of 5.4 tons and less, including residential and very small commercial systems, and could extend or expand this standard for the next class of VC equipment, including RTU and VRF systems. We recommend engaging AHRI to develop a new DR control standard for variable-speed RTU and VRF systems that apply to light commercial buildings. Alternatively, AHRI may decide it is easier to modify Standard 1380 to expand applicability to this equipment segment.

APPENDIX A: SITE 1 TEST DATA

Figure 21 through Figure 33 show the VRF system's measured parameters on each test event day compared to similar "baseline" days. For Tests 2 through 13, load was added to the system using the demonstration units, and the system was loaded in that way for each of the corresponding baseline days. Total system power (kW) is shown in red on the top plot, corresponding to the y-axis on the left. Outdoor temperature is overlaid to the top plot in yellow, corresponding to the y-axis on the right. Indoor temperatures in the five zones are plotted on the bottom graph. DR events are shaded light blue, the ramped recovery period after the event (if applicable) is shaded orange, and the pre-cooling period for Test 11 is shaded fuchsia (pink/purple). Please refer to Table 9 for complete details on each test event and the demand reduction results.

Figure 21 shows Test 1, which tested the Capacity Limit function, with a limit of 50% system capacity from 1-2 p.m., allowing a 2°F deviation from setpoint in any single zone. After analyzing Test 1 performance, we determined VRF system load was low. For all other tests, thermal load was added to the system as described earlier, and Test 1 cannot be compared to the subsequent DR test events.

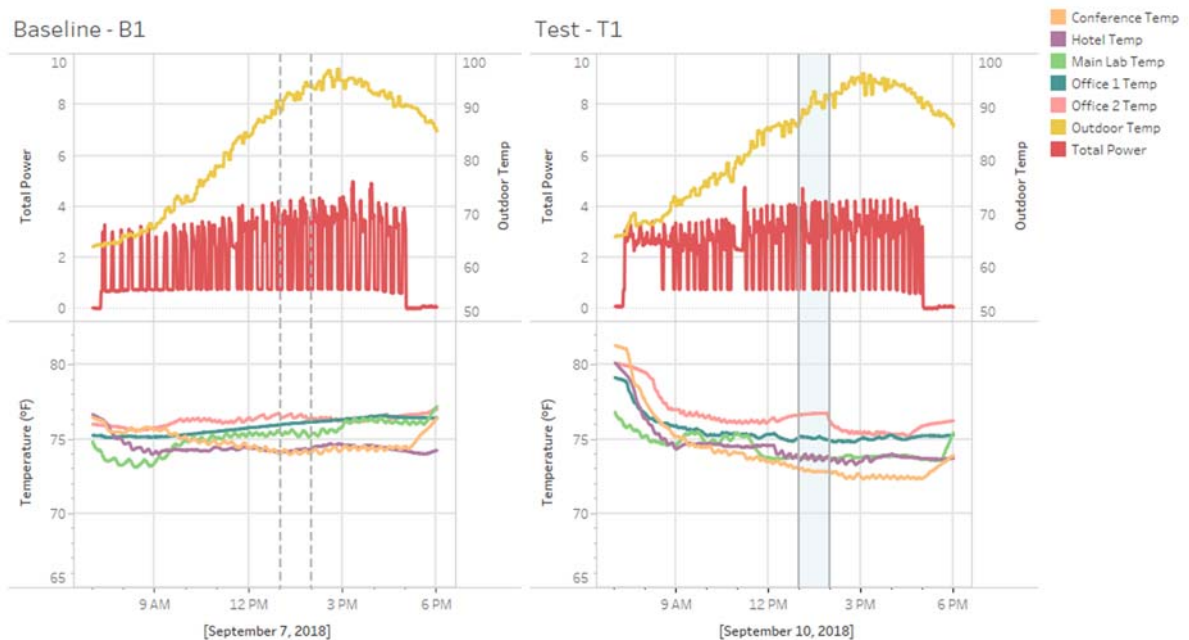

FIGURE 21: SITE 1 TEST EVENT DETAILS AND BASELINE COMPARISON – TEST 1

Figure 22 shows Test 2, a Capacity Limit event (50%) from 1-2 p.m., allowing 2°F deviation from any zone.

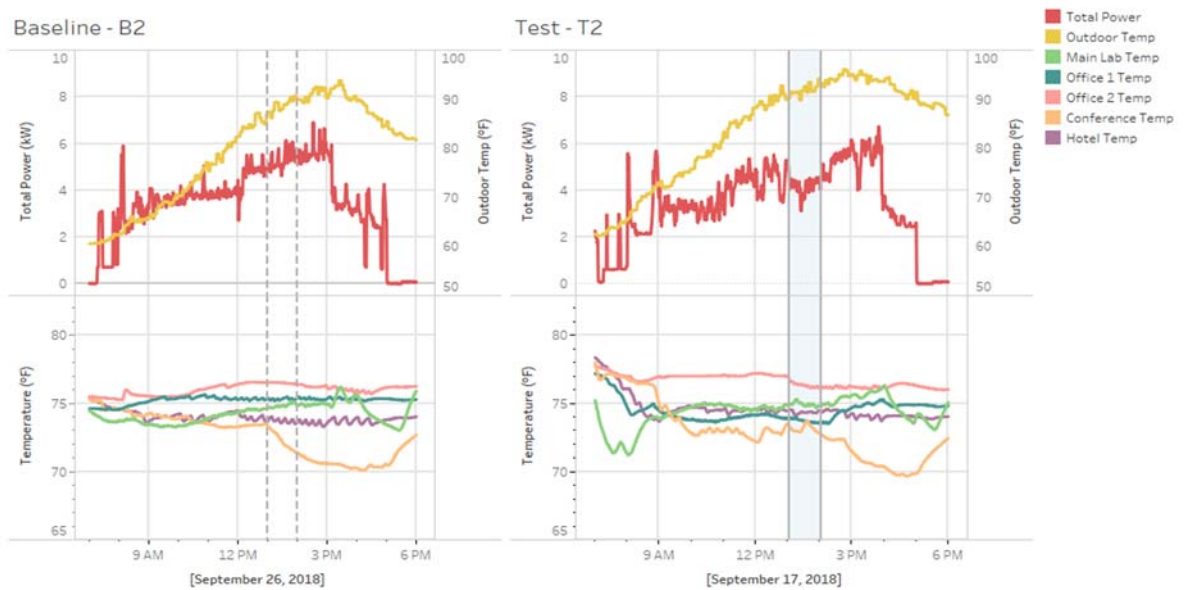

FIGURE 22: SITE 1 TEST EVENT DETAILS AND BASELINE COMPARISON – TEST 2

Figure 23 shows Test 3, a Capacity Limit event (50%) from 1-3 p.m., with 1°F allowed in any zone.

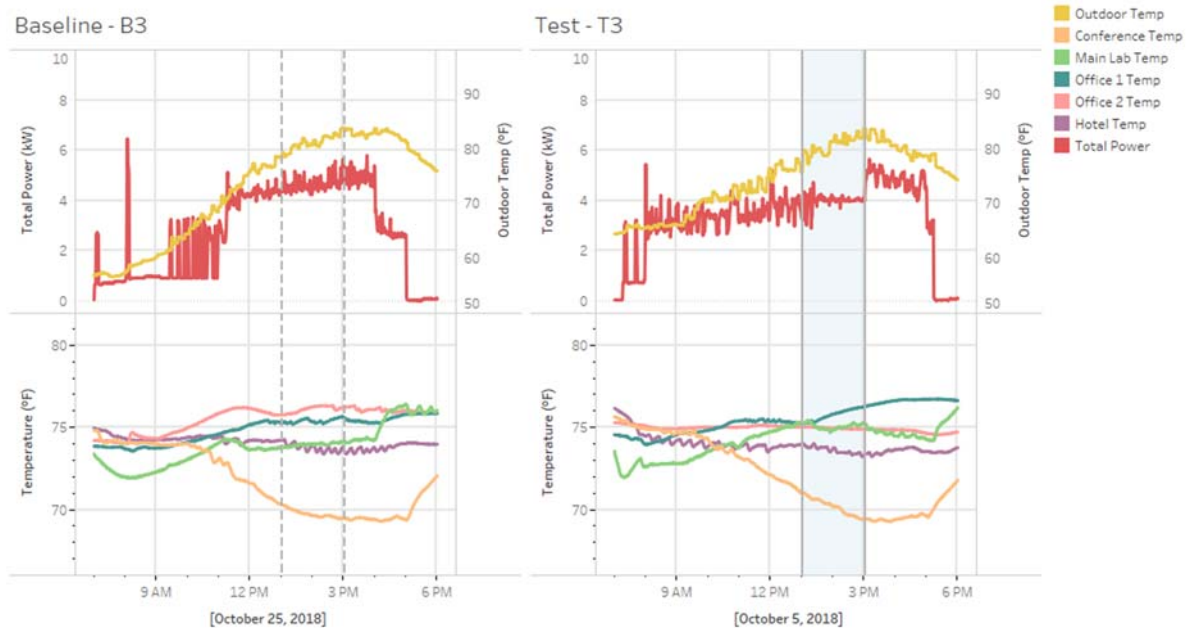

FIGURE 23: SITE 1 TEST EVENT DETAILS AND BASELINE COMPARISON – TEST 3

Figure 24 shows Test 4, a Temperature Setpoint Offset of 2°F from 1-3 p.m.

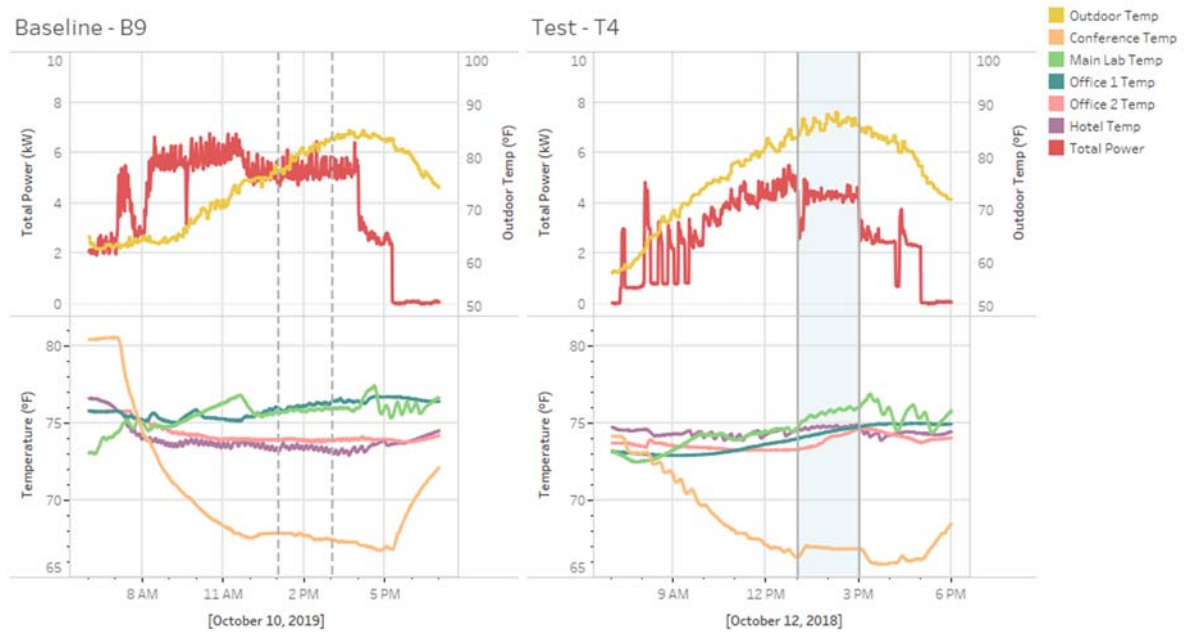

FIGURE 24: SITE 1 TEST EVENT DETAILS AND BASELINE COMPARISON – TEST 4

Figure 25 shows Test 5, a Capacity Limit (50%) from 1-2 p.m., with 3°F allowed from one single zone, followed by a 30-minute recovery period.

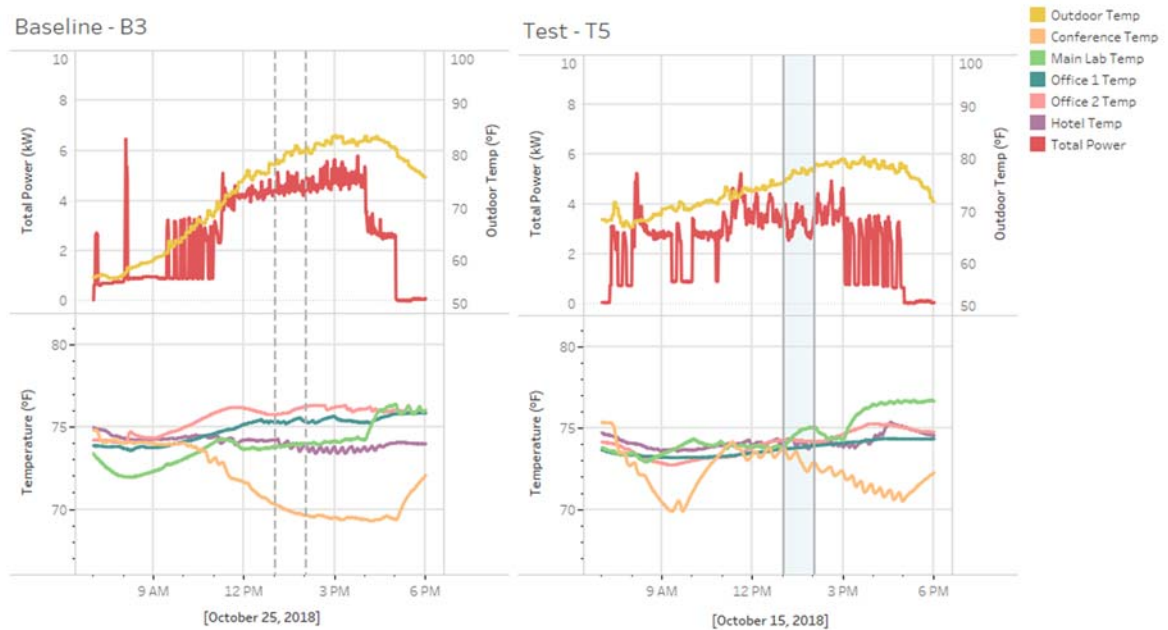

FIGURE 25: SITE 1 TEST EVENT DETAILS AND BASELINE COMPARISON – TEST 5

Figure 26 shows Test 6, a Temperature Setback of 3°F from 1-2 p.m.

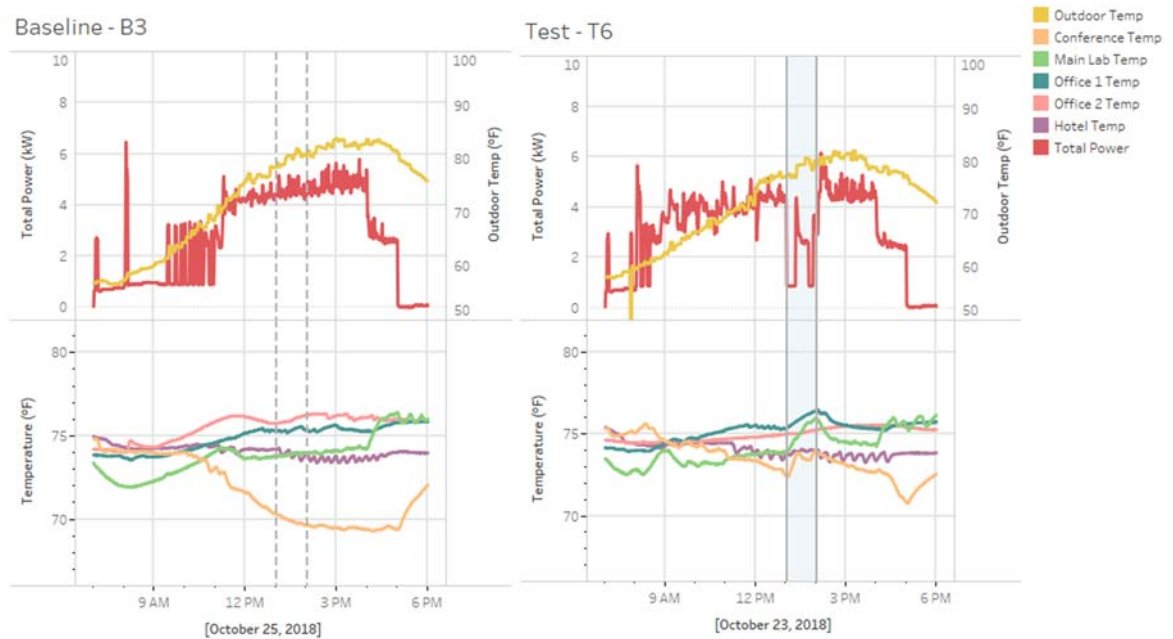

FIGURE 26: SITE 1 TEST EVENT DETAILS AND BASELINE COMPARISON – TEST 6

Figure 27 shows Test 7, a Temperature Setback of 2°F from 1-3 p.m.

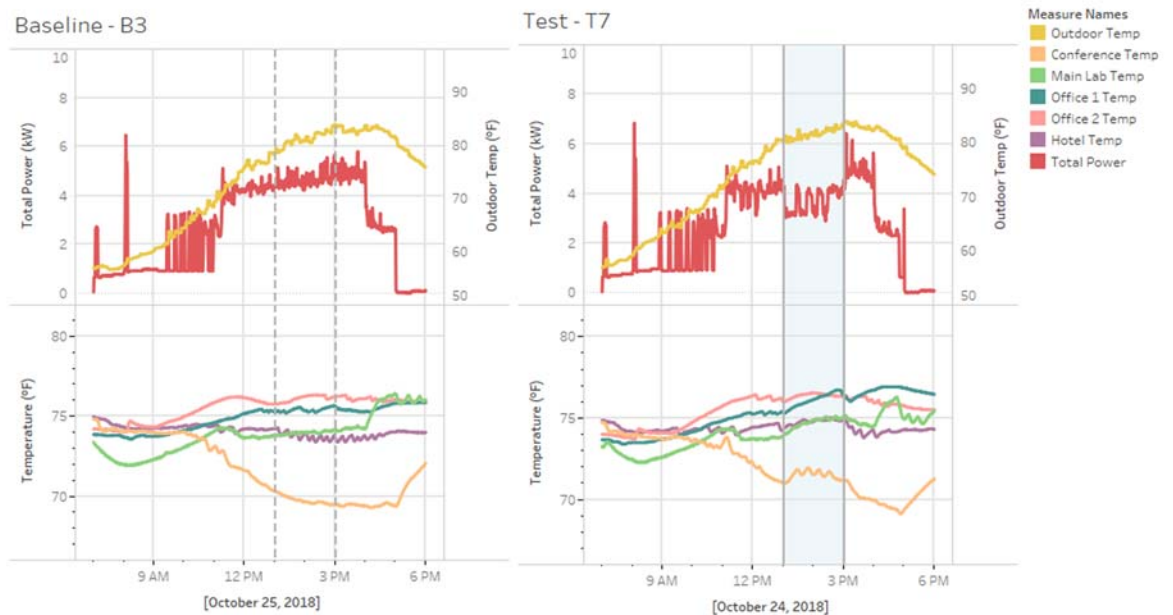

FIGURE 27: SITE 1 TEST EVENT DETAILS AND BASELINE COMPARISON – TEST 7

Figure 28 shows Test 8, a Capacity Limit (50%) from 1-3 p.m., allowing a 2°F average deviation from all zones, followed by a 30-minute recovery period.

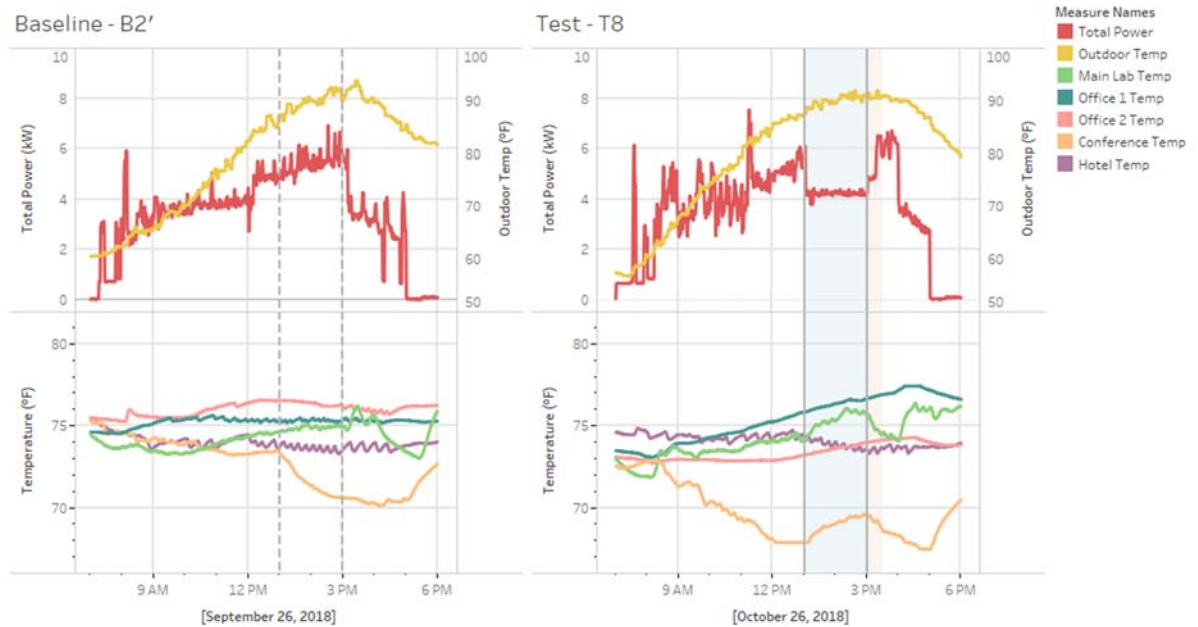

FIGURE 28: SITE 1 TEST EVENT DETAILS AND BASELINE COMPARISON – TEST 8

Figure 29 shows Test 9, a Temperature Setback (3°F) from 1-2 p.m., with 60-minute recovery. The ramped recovery function did not operate properly, but instead abruptly changed setpoints back to their prior values at the end of the recovery period.

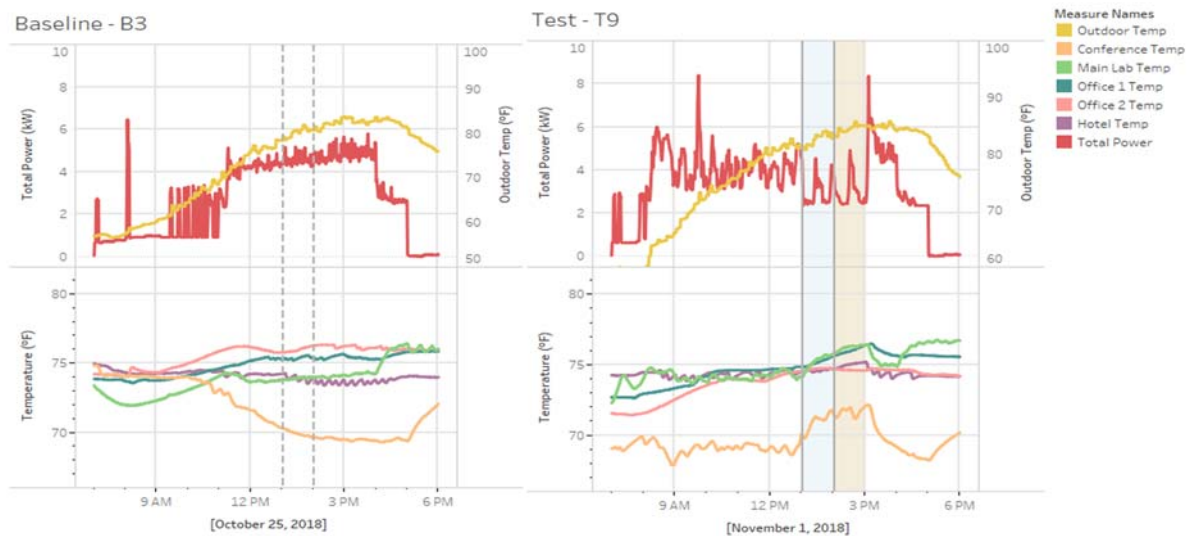

FIGURE 29: SITE 1 TEST EVENT DETAILS AND BASELINE COMPARISON – TEST 9

Figure 30 shows Test 10, a Temperature Setback (3°F) from 1-2 p.m., with 60-minute recovery. Once again, the ramped recovery function did not operate properly, reverting setpoints back to prior settings, this time at the beginning of the recovery period.

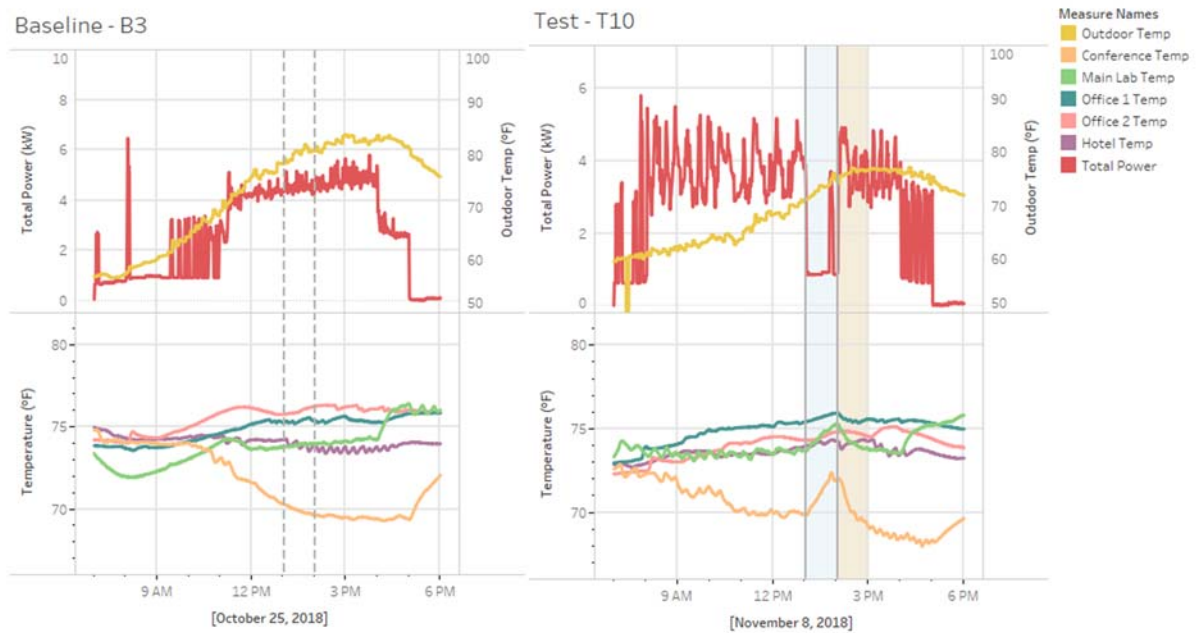

FIGURE 30: SITE 1 TEST EVENT DETAILS AND BASELINE COMPARISON – TEST 10

Figure 31 shows Test 11, a Temperature Setback (3°F) from 1-2 p.m., with 60-minute recovery. In this case, ramped recovery was found to properly ramp setpoints back to their prior values, since Manufacturer B had updated the control algorithm.

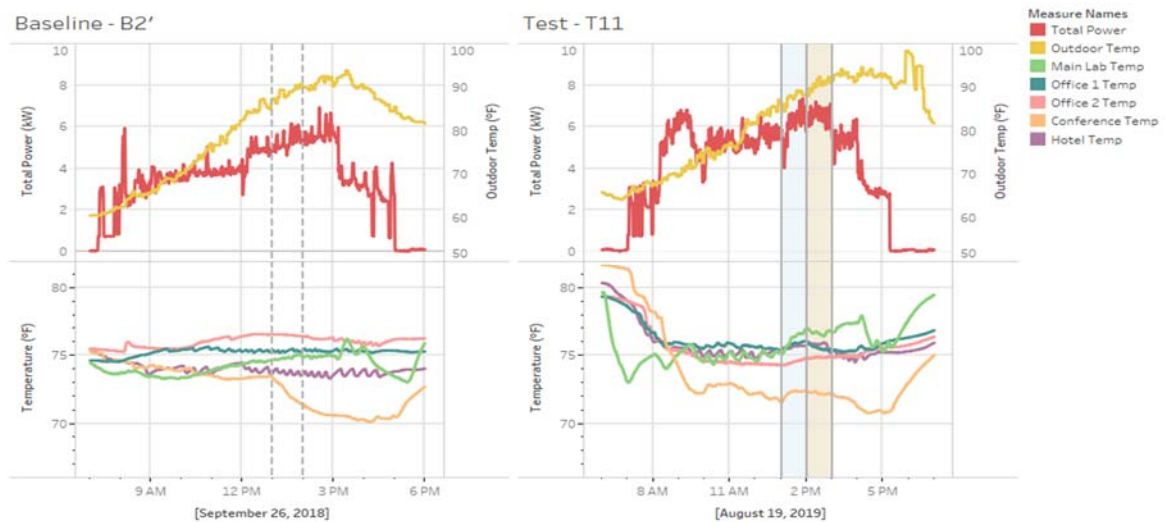

FIGURE 31: SITE 1 TEST EVENT DETAILS AND BASELINE COMPARISON – TEST 11

Figure 32 shows Test 12, a pre-cooling event that decreased the setpoint of all zones by 2°F from 12-1 p.m., then applied a Capacity Limit (50%) with 2°F average deviation allowed, followed by a 60-minute recovery. The pink bar represents the load-up period before the event, and the orange bar shows the recovery period.

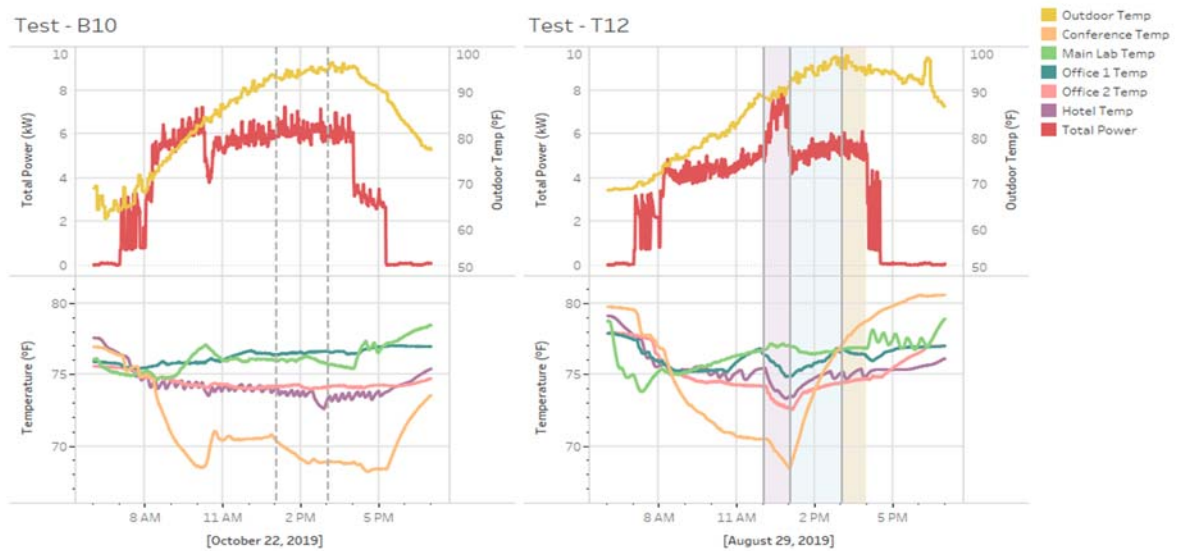

FIGURE 32: SITE 1 TEST EVENT DETAILS AND BASELINE COMPARISON – TEST 12

Figure 33 shows Test 13, a Capacity Limit (50%) from 2-3 p.m., with 3°F average deviation allowed, followed by a 60-minute recovery. This ramped recovery period was found to improperly release the system immediately back to 100% capacity at the beginning of the recovery period.

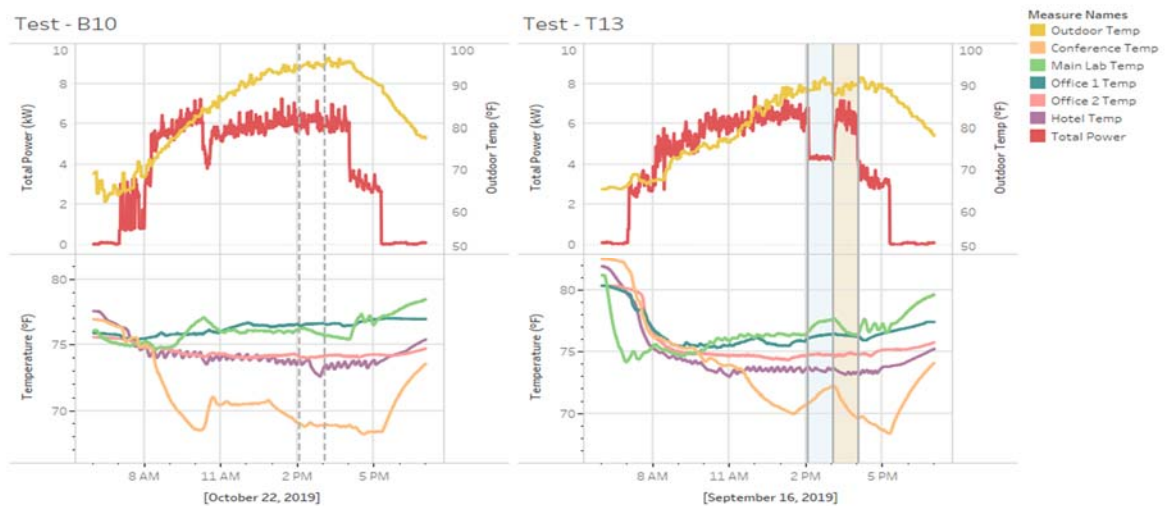

FIGURE 33: SITE 1 TEST EVENT DETAILS AND BASELINE COMPARISON – TEST 13

Figure 34 shows Test 14, a Capacity Limit (50%) from 1-3 p.m., with 3°F average deviation allowed, with a 60-minute recovery period that was found to properly ramp capacity back to 100%. However, since the capacity limit had already been increased to 75% due to indoor zone temperature deviation, the system ramped its capacity limit from 75% to 100%, thereby releasing the final capacity stage (again, this unit only has 50% and 75% stages available for control).

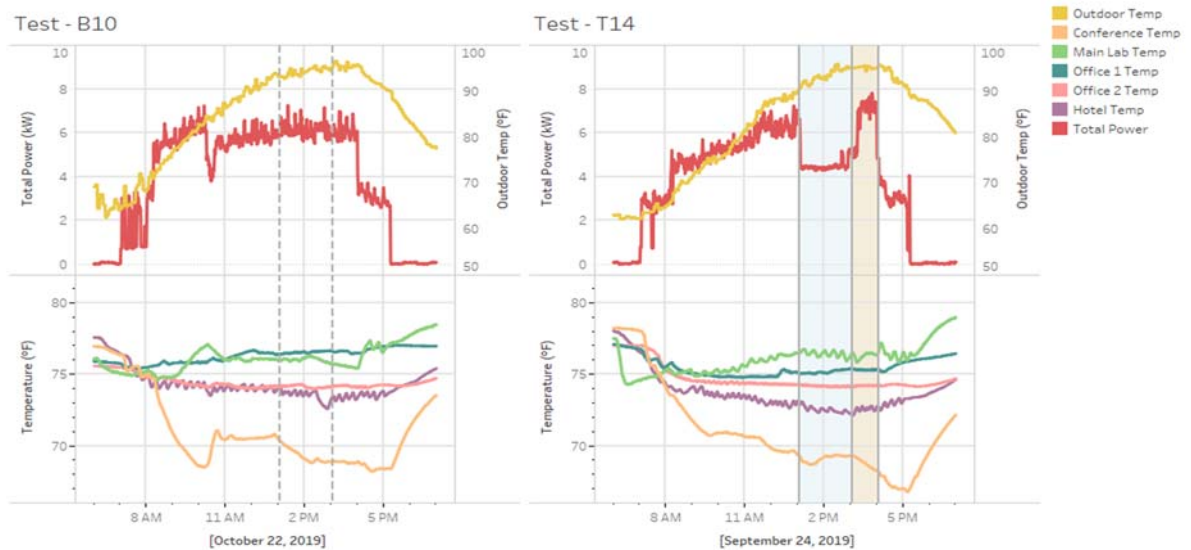

FIGURE 34: SITE 1 TEST EVENT DETAILS AND BASELINE COMPARISON – TEST 14

Figure 35 shows Test 15, a Targeted Capacity Reduction function enabled from 1-2 p.m., targeting a 50% reduction in capacity while allowing a 2°F deviation in each zone.

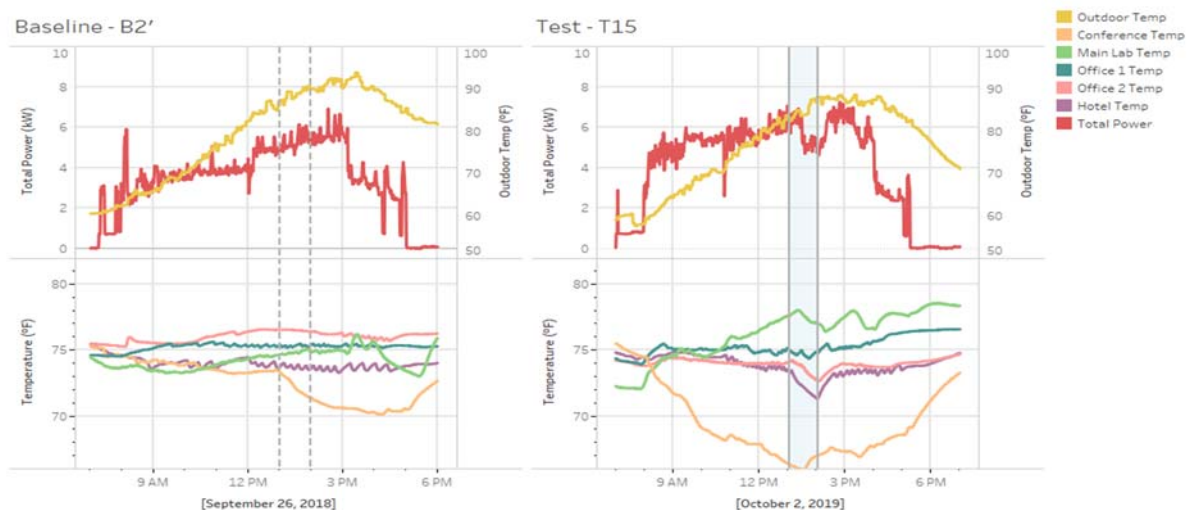

FIGURE 35: SITE 1 TEST EVENT DETAILS AND BASELINE COMPARISON – TEST 15

APPENDIX B: SITE 2 TEST DATA

Figure 36 through Figure 41 show Site 2 RTU measured test data. Each event is shown in comparison with a similar baseline day. For each day, the top plot shows total RTU power, while the bottom plot shows outdoor temperature, indoor temperature (measured near the thermostat), and supply and return air temperature (the latter two measured within the RTU ducting). Shed events are shaded blue, with recovery periods shaded orange. For complete results, please refer to Table 10.

Figure 36 shows Test 1, a Temperature Setpoint Offset event of 2°F from 1-2 p.m. It is unclear whether the DR command was successfully applied during this event, since the RTU did not seem to respond to the setpoint offset request.

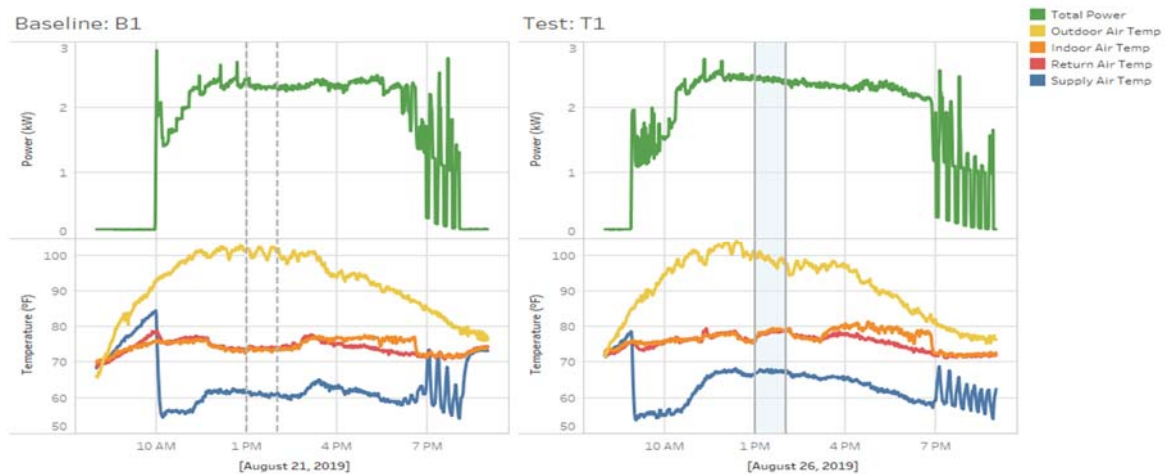

FIGURE 36: SITE 2 TEST EVENT DETAILS AND BASELINE COMPARISON – TEST 1

Figure 37 shows Test 2, a Setpoint Offset of 2°F from 1-3 p.m.

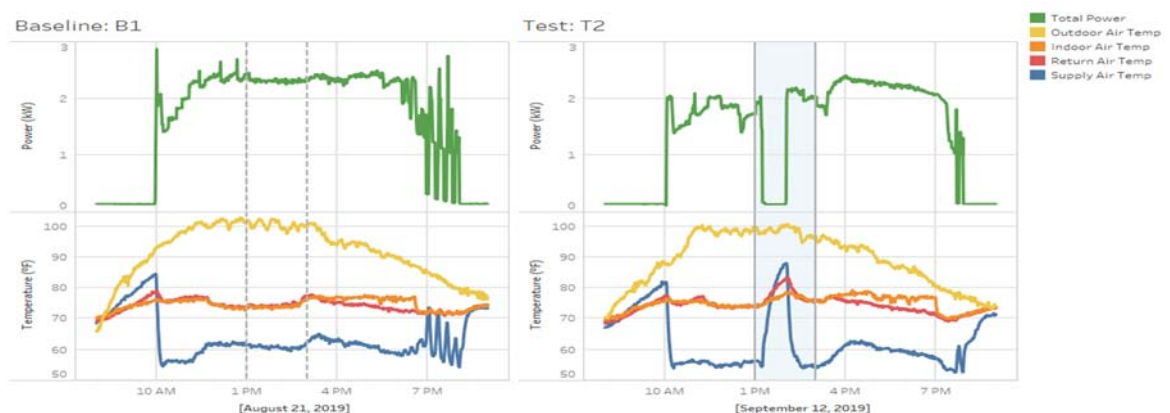

FIGURE 37: SITE 2 TEST EVENT DETAILS AND BASELINE COMPARISON – TEST 2

Figure 38 shows Test 3, a Setpoint Offset of 2°F from 1-3 p.m., with an attempted ramp rate of 1°F/hr. (rejected by the RTU controller).

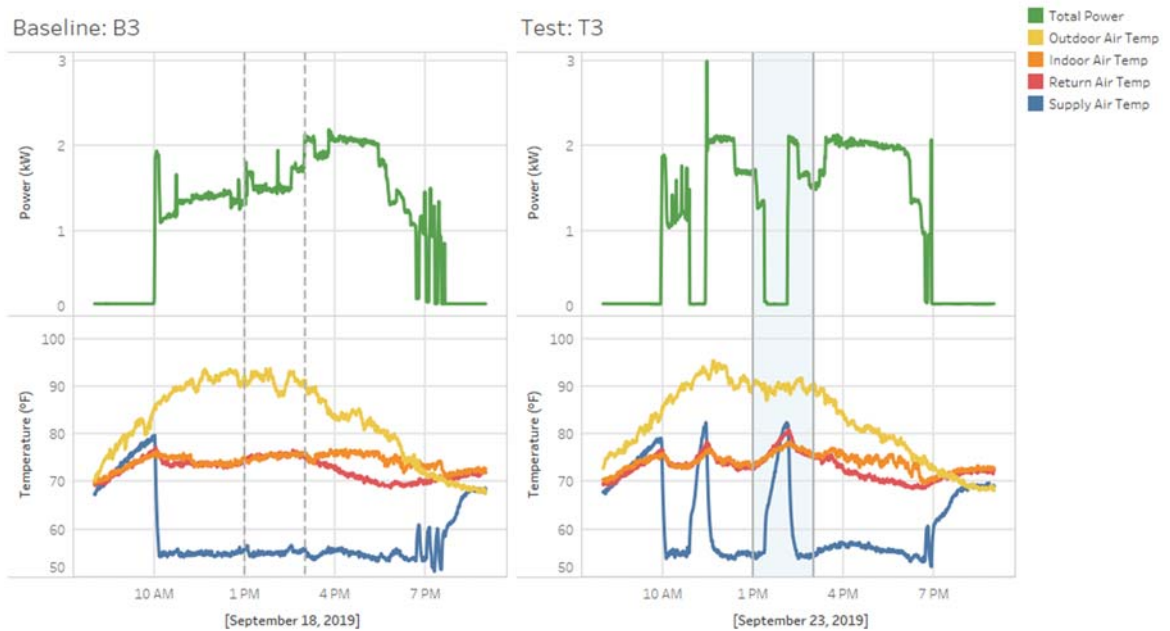

FIGURE 38: SITE 2 TEST EVENT DETAILS AND BASELINE COMPARISON – TEST 3

Figure 39 shows Test 4, a Setpoint Offset of 4°F from 1-3 p.m., with a two-hour recovery period and ramp rate of 2°F/hr.

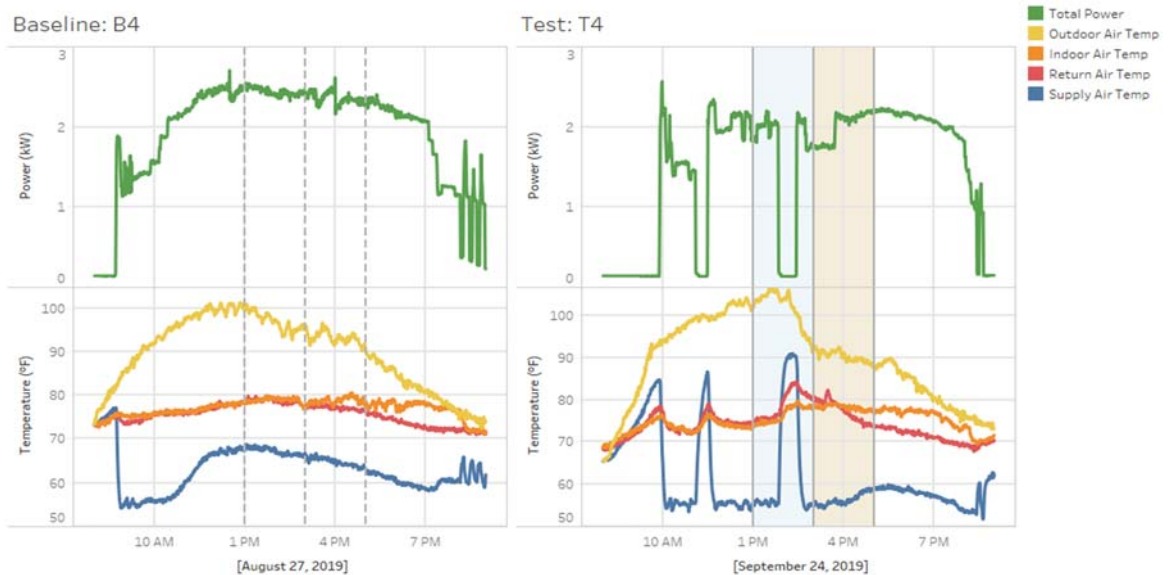

FIGURE 39: SITE 2 TEST EVENT DETAILS AND BASELINE COMPARISON – TEST 4

Figure 40 shows Test 5, a Setpoint Offset of 4°F from 1-2 p.m., with no ramp. It is unclear whether the DR command was successfully applied during this event, since the RTU did not seem to respond to the setpoint offset request.

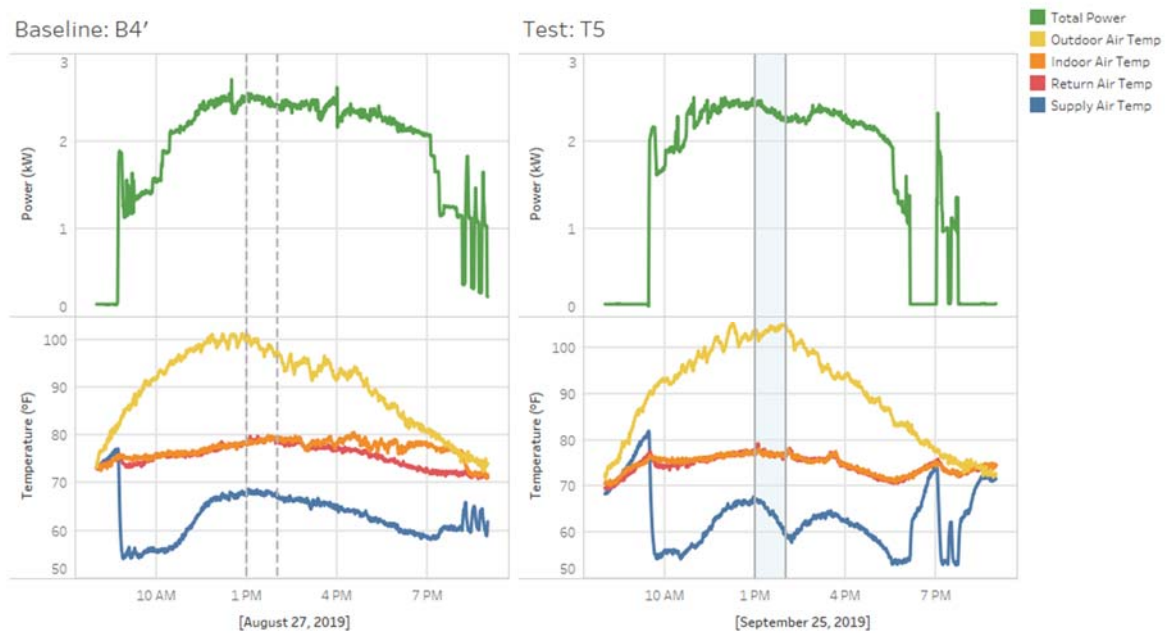

FIGURE 40: SITE 2 TEST EVENT DETAILS AND BASELINE COMPARISON – TEST 5

Figure 41 shows Test 6, a Setpoint Offset of 4°F from 1-3 p.m., with two-hour recovery period and ramp rate of 2°F/hr.

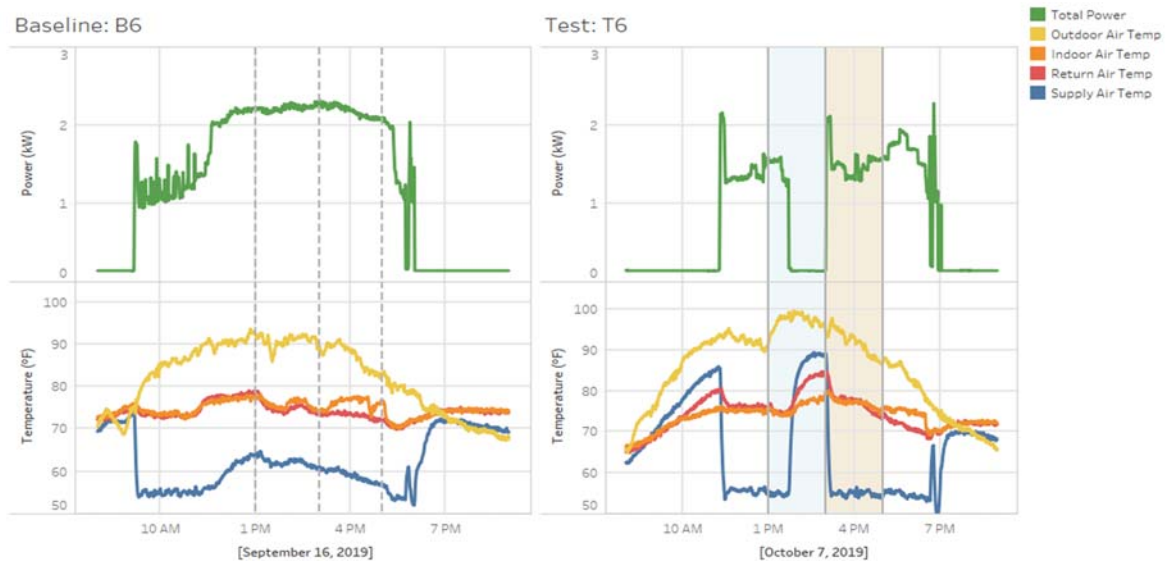

FIGURE 41: SITE 2 TEST EVENT DETAILS AND BASELINE COMPARISON – TEST 6

REFERENCES

- [1] "Field Analysis of Commercial Variable Refrigerant Flow Heat Pumps," ETCC, ET Project Number: ET12PGE1381, 2014.
- [2] *Energy Efficiency Demonstration*, Palo Alto, CA: EPRI, 2012. 1025437.
- [3] *Assessment of Commercial Space Conditioning Technologies: Variable-Capacity Rooftop Units*, Palo Alto, CA: EPRI, 2013. 300201380.
- [4] "Variable-Capacity Rooftop Unit: Evaluation of Field Performance for San Diego Gas & Electric (SDG&E)," EPRI, Palo Alto, CA, 2016. 3002008880.
- [5] J. Robinson, R. Narayanamurth, B. Clarin, C. Lee and P. Bansal, "National Study of Potential of Smart Thermostats for Energy Efficiency and Demand Response," ACEEE Summer Study on Energy Efficiency in Buildings, 2016.
- [6] "AHRI Standard 210/240: Performance Rating of Unitary Air-conditioning & Air-source Heat Pump Equipment," Air-Conditioning, Heating and Refrigerating Institute, 2017. <http://www.ahrinet.org>.
- [7] "AHRI Standard 340/360: Performance Rating of Commercial and Industrial Unitary Air-conditioning and Heat Pump Equipment," Air-Conditioning, Heating and Refrigerating Institute, 2015. <http://www.ahrinet.org>.
- [8] "ASHRAE Standard 90.1: Energy Standard for Buildings Except Low-Rise Residential Buildings," American Society of Heating, Refrigerating and Air-Conditioning Engineers, 2016. <https://www.ashrae.org>.
- [9] "Variable Refrigerant Flow Market Study," EPRI, Palo Alto, CA, 2016. 3002008752.
- [10] "Field Analysis of Commercial Variable Refrigerant Flow Heat Pumps," EPRI, Palo Alto, CA, 2014. 3002004364.
- [11] *Common Demand Response Functions for Heating, Ventilating, and Air Conditioning (HVAC): A Summary of Demand Response Functionality Discussed in the Industry to Date*, Palo Alto, CA: EPRI, 2017. 3002011045.
- [12] Energy Solutions, "Market Characterization Study of Automated Demand Response Capabilities of Variable Refrigerant Flow Technologies," Southern California Edison, Rosemead, CA, 2017.
- [13] California Energy Commission, *Title 24, Part 6: 2016 Building Energy Efficiency Standards for Residential and Nonresidential Buildings*, Sacramento, CA, 2015.
- [14] *2019 Standard for Demand Response through Variable-Capacity HVAC Systems in Residential and Small Commercial Applications*, Arlington, VA: Air-Conditioning, Heating, and Refrigeration Institute, 2019.
- [15] "Peak Load Management of Thermal Loads: Laboratory Evaluation of Demand Response Performance for a Residential Variable Speed HVAC System," Palo Alto, CA., 2019. 3002016223.
- [16] "Peak Load Management of Thermal Loads: Laboratory Evaluation of Demand Response Capabilities for Residential HVAC Systems," Palo Alto, CA, 2018. 3002013408.